

Welcome to your fax machine

- | | | |
|---------------------------------|------------------------------------|---|
| A Document guides | H Paper load lever | O Left paper guide release lever |
| B Document tray | I Right envelope guide | P Left envelope guide |
| C Document tray cover | J Right paper release lever | Q Left paper guide |
| D Access door for PC | K Right paper guide | R Document exit tray |
| E Access door for memory | L Paper support | S Recording paper exit tray |
| F Top Cover | M Automatic sheet feed | T Operation panel |
| G Manual feed | N Left paper guide | U Ink cartridge storage unit |

- | | | |
|---|---|---|
| 1 LCD Display
Displays indications about the operating modes of your fax machine. Your control monitor for all function settings. | 10 Printer reset
Ejects the sheet drawn into the machine, and cancels the print job. | 19 Handset
Used for on-hook dialling. |
| 2 Alarm-LED
Flashes when a machine error occurs. | 11 Change cartridge
Press to change the ink cartridge. The printhead moves to the change position. When the cartridge has been replaced, press to return to the ready position. | 20 "*" and "#" Key
Used to move the cursor to the left or right. |
| 3 Busy LED
Flashes or lights up when the fax machine connects to the line or is just transmitting or receiving | 12 Group
Press the key to use the group facility. This enters a space during programming. | 21 Dial Keypad
Used for entering telephone numbers. |
| 4 Job Status
Queries the status of the entered jobs. | 13 One Touch Dialing keys
Sends documents at the push of a button. | 22 R Key
Key for obtaining public line in PABXs. Pages backwards in the menu. |
| 5 Function
Initiates all machine settings. | 14 Copy
Makes a copy of your original. | 23 ABB. DIAL /ALPHABET
Press this key in order to select a stored alphabet dial number or a name. |
| 6 Job cancel
Deletes jobs in the memory or deletes the last entry during programming. | 15 Option
When document has been inserted into machine, press to select special settings for document transmission. | 24 AUTO RCV KEY
Switches between automatic and manual reception. |
| 7 Draft quality/letter quality LED
Switches between draft quality and letter quality when documents are printed from the PC. | 16 Start
Indicates the sending and receiving options, confirms entries. | 25 Resolution Key
Changes the scan resolution of the loaded originals. |
| 8 PC printing LED
Lights up when data are received from the PC or when a fax document is printed out. | 17 Stop
Clears error messages and terminates input. | |
| 9 Feed
Ejects the paper drawn into the machine when a document is printed from the PC. Draws sheets into the single sheet feeder. | 18 Redial/pause
Activates the last number dialled, inserts a dialling pause and pages forwards in the menu. | |

Contents

Preparation

Unpacking	4
Connection to the mains	4
How to insert the recording paper:	5
To install the accessories:	5
Insert the inkcartridge	6

Installation

Set language	8
Enter terminal ID	9
Enter the user name	10
Connection to PABX, obtaining a public line	12
Connection to PABX, further settings	14
Set date and time	15

Reception of documents

Set standby mode	16
Automatic reception	16
Manual reception	16
Manual reception (continued)	17
TEL/FAX mode:	18
FAX/TAD mode:	18
Switching between reception modes	19
FAX/TAD mode: (continued)	19
Reception reduction	20
Local copy	20
Set call counter	21
Memory reception	21

Transmit documents

Document format	22
Stack mode	23
Direct transmission	24
Automatic fax messages	25
Transmission with alphabet dialling	26
Transmission with one-touch dialling	26
Transmission with telephone (manual transmission)	27
Transmission with directory function	28
Monitoring	29
Set resolution	30
Redial	30

Delayed transmission	31
Single multi-address transmission	32
Stored broadcast	33
Polling	34
Reserve polling	35
Reduce transmission speed	36
Stop transmission	37

Store numbers

Alphabet dial memory	38
One-touch dial keys	40
Group keys	40

Report prints

Activate printing report	43
Transmission report	43
Transmission and reception journal	44
The multitransmission report	45
Number list	45
Group list	45
Jobs in progress	45
The function list	46

Advanced settings

Functions	47
Connection to PABX	51
Receive footer on/off	51
Change speaker volume	52
Adjust ringing tone/key beeps	53
Set transmission report output	54

Possible problems

Error codes in journal	55
Error messages in the Display	56
Transmission problems	57
Remove paper jam in the document feed area	59
Remove paper jam before document tray	59
Document jam	59

Your TF 461 as a printer

System requirements	60
Connecting the fax machine to the computer	60
Changing the ink cartridge	61
Loading the paper	61
Paper formats	61
The automatic sheet feed	62
The automatic envelope feed	62
The manual single sheet guide	63
Installing the printer driver software	63
Printer setup (colour printer)	69
Paper	70
Media / quality	70
Document type	71
Ink / resolution	71
Image settings	72
Halftones	72
Printer setup (monochrome)	73
The printer statusdisplay	75
The spool manager	76
The Toolkit	78
Setting the standard printer	81
Configuration of the printer	82
Draft/ LQ printing	82
Paper orientation	82

Configuration of the printer

Adjust alignment	83
Cleaning the printhead	84
Test printout	84
Hex dump mode	85

Handling faxes on your PC

System requirements	86
Features	86
Connection to the PC	87
Scanning documents into the PC	88
Sending fax messages from the PC	88
Sending faxes to the PC	89

UK Connection information

UK Connection information	90
---------------------------------	----

Index

Index	91
-------------	----

Preparation

Unpacking

When unpacking your machine, please check that all parts shown here are present and in perfect condition.

1. Fax machine

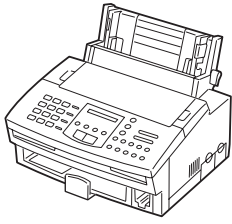

2. User manual

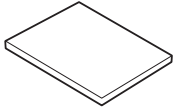

3. Powercable

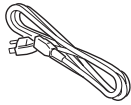

4. Telephone cable
(not supplied in
all Countries)



5. Ink cartridge

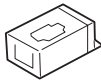

6. Paper support



7. Discs

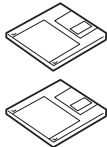

8. Exit document tray

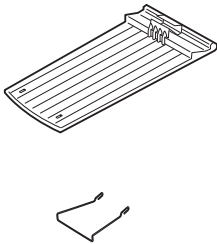

The correct location
for your fax machine is:

- near a 230 V AC socket*,
 - near a telephone connection, ideally with a single line reserved for your fax machine.
- * No other equipment with high power consumption (such as a photocopier) or equipment which generates electrical noise (such as a radio, computer, radio transmitting and receiving equipment) should be connected to this mains supply.

AC power

You will find the mains connection on the back of the machine.

Please protect your machine from:



vibration



direct sunlight



dust



humidity

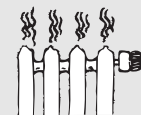

heat

Connection to the mains

Ensure contact and operating voltage.

Telephone connection

Connect your fax machine (LINE jack) to the telephone socket, as shown on the right.

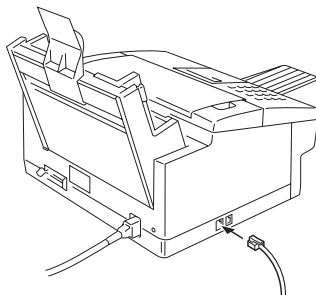

Preparation

How to insert the recording paper:

Adjust the left paper guide as illustrated in the diagram. To adjust the guide, press the left paper release lever.

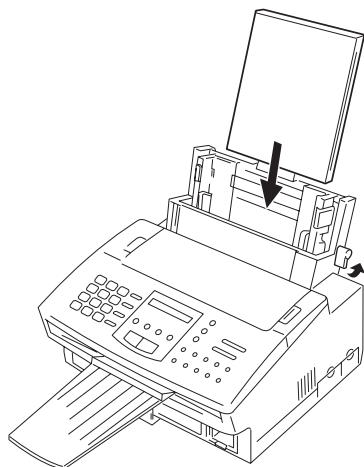

Insert a stack of A4 paper.

Prepare the recording paper by flexing and fanning out the stack to separate the sheets.

Press back the paper release lever.



Do not insert any paper before pushing back the release lever.

Insert the paper. Do not push it underneath the feed rollers.



The paper cassette holds a maximum 150 sheets (80 g/sm). Do not use the right paper guide.

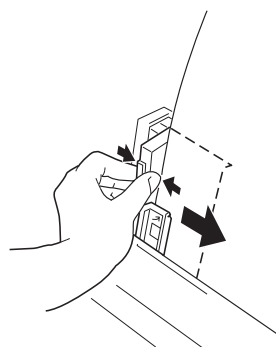

Pull the paper release lever to the front.



Do not use damp, wrinkled or torn paper.

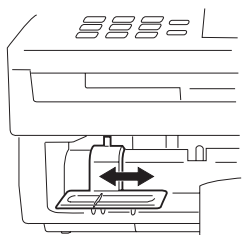

Adjust the recording paper guide to suit the paper format used

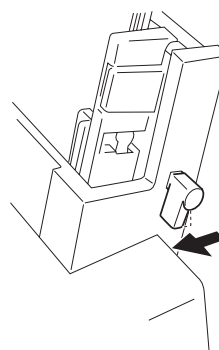

To install the accessories:

If required, press the document support into the retaining holes.
Remove the recording paper tray.

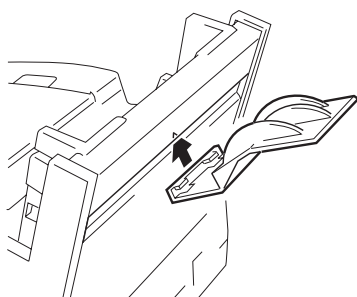

Insert the paper support as illustrated

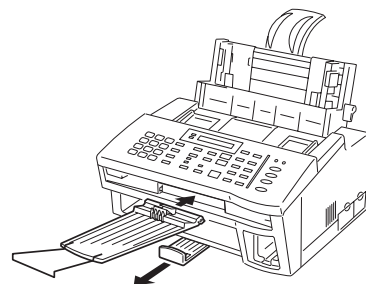

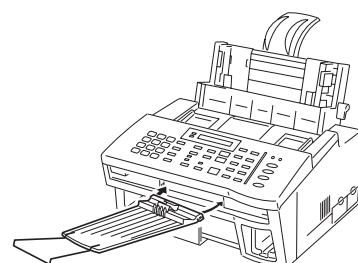

Switch on the machine



Preparation

Insert the ink cartridge

 In order to prevent transport damage, the high-quality process unit of your new fax machine is delivered in special packaging to provide additional protection. Please follow the enclosed instructions. This is how to install the unit:

 Please remove the ink cartridge if you transport or ship the machine.

Lift up the operating panel

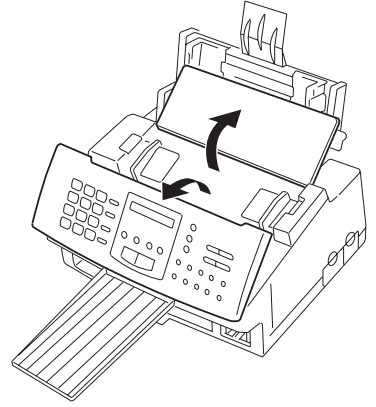

Lift up the upper machine cover

You can now look into your machine

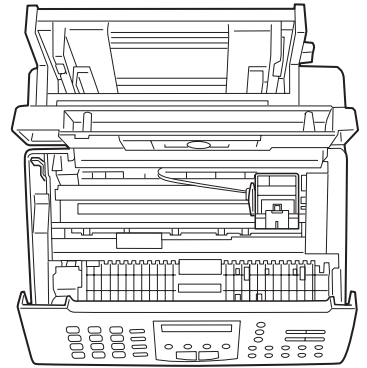
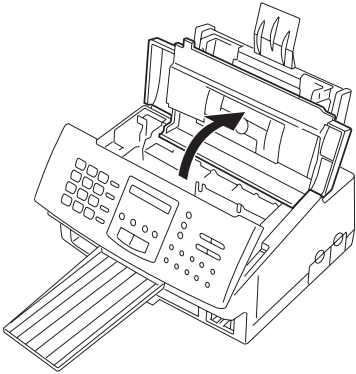



Press

 CHANGE CARTRIDGE

 CHECK CARTRIDG M100%

 Replace the ink cartridge only when the print unit has moved to the left into the change position. You will damage the machine if you change the ink cartridge in any other position!

 If the print unit is not in this position, press the following again:

 CHANGE CARTRIDGE

Open the packaging. Remove the protective strip

 Do not open before you intend to use the cartridge!

 Hold the cartridge only on the blue (black-and-white cartridge), red (colour cartridge) or black positions !

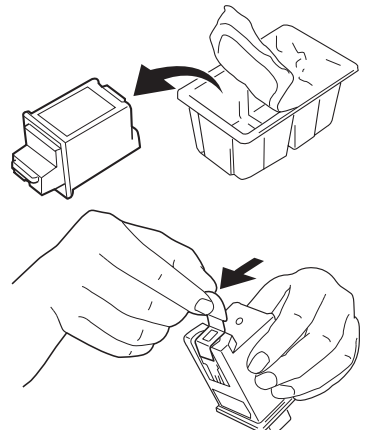

Preparation

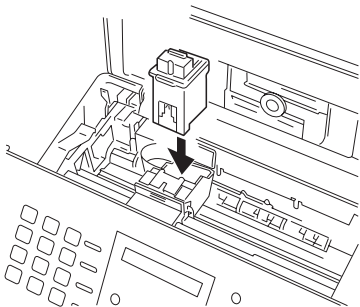

Insert the new cartridge



You must be able to see the gold contact strip!

Click the cartridge into position. Do not worry, you will hear a loud "click" when the cartridge is pressed into position.

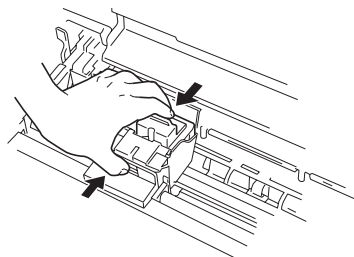

CHANGE CARTRIDGE



Press ...

NEW CARTRIDGE ?

Is the cartridge new or was it used ?

NEW

Go to A

USED

Go to B

A

NEW



START

Confirm the new cartridge

CLEAR INK COUNTER

The print counter is set to zero

B

USED



STOP

The print unit returns to the starting position

15-03 19:56 M 100%

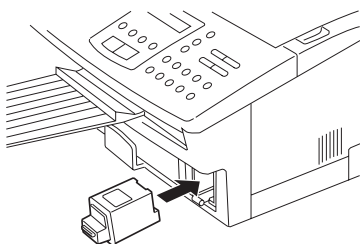

Buy a spare cartridge or a colour cartridge directly from your dealer. You can store both cartridges in the special cartridge compartment, even if the cartridge has already been opened.

Installation

Set language

Your fax machine is set to English. Please carry out the following menu steps if you wish to use another language for the menu and the list prints.

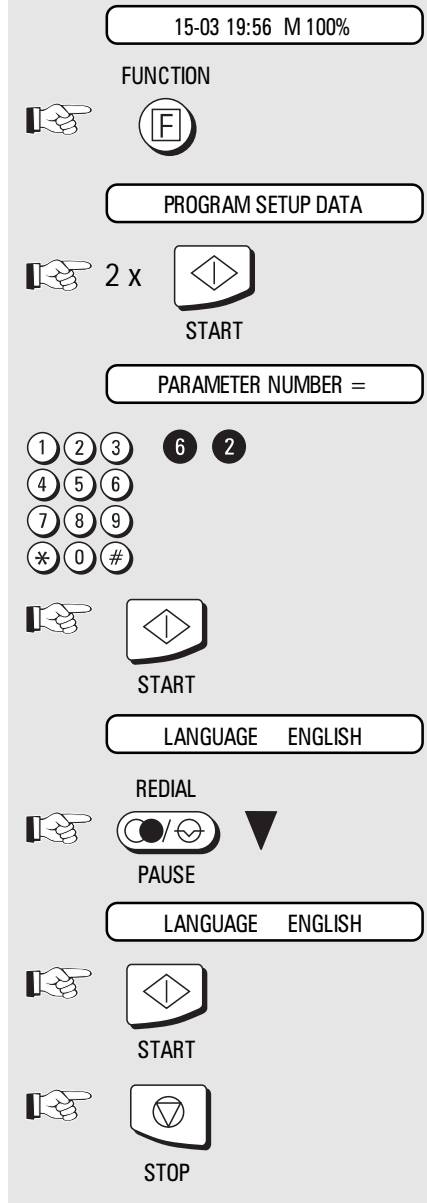

Standby mode

Start the menu

Confirm with START (2x)

Make your selection

Enter function number

Confirm with START

Set language

Page through the menu...

...until you reach this menu item

Confirm with START

Press STOP, return to standby mode

Installation

Enter terminal ID

The terminal ID which is part of the transmitting header contains the number under which your fax machine can be reached. The number should be entered in the international format:

Example:

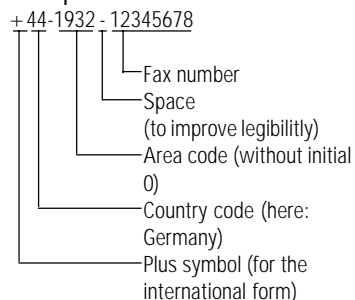

To enter the characters:

Character	Key to be pressed
+	Public line key /
Hyphen	Alphabet dialling/ALPHA key

Enter the actual figures via the dial keypad (as usual).

If you have entered a wrong number, you can delete this number by means of the **CANCEL** key.



In Germany, the terminal ID must be entered!

*) If there is a pause of more than one minute between each entry, the fax machine automatically switches over to the standby mode. In this case, the contents which are entered are NOT stored.

15-03 19:56 M 100%

FUNCTION

PROGRAM SETUP DATA

START

REDIAL

5 x PAUSE

LOCAL ID NUMBER

ID:

1 2 3
4 5 6
7 8 9
* 0 #

+44 1932 12345678

START

STOP

Standby mode

Start the menu

Confirm with START

Page through the menu...

...until you reach this menu item.

Confirm with START

Make your selection

Enter the terminal ID (see Infotext)

Terminal ID is complete

Confirm with START*)

Press STOP, return to standby mode

Installation

Enter the user name

The transmission header not only contains the terminal ID but also the user name. This can contain up to 20 characters. Each digit features several characters which can be activated by repeatedly pressing the corresponding key. If you have found a character of your choice, press the „#“ key to got to the next position. Use the „*“ key to got back one letter and make any corrections. Use the „0“ key to select special characters. If you enter too many characters, press the CANCEL key to delete the unwanted characters.

When the name is complete, press the **START** key.

Example: TOSHIBA

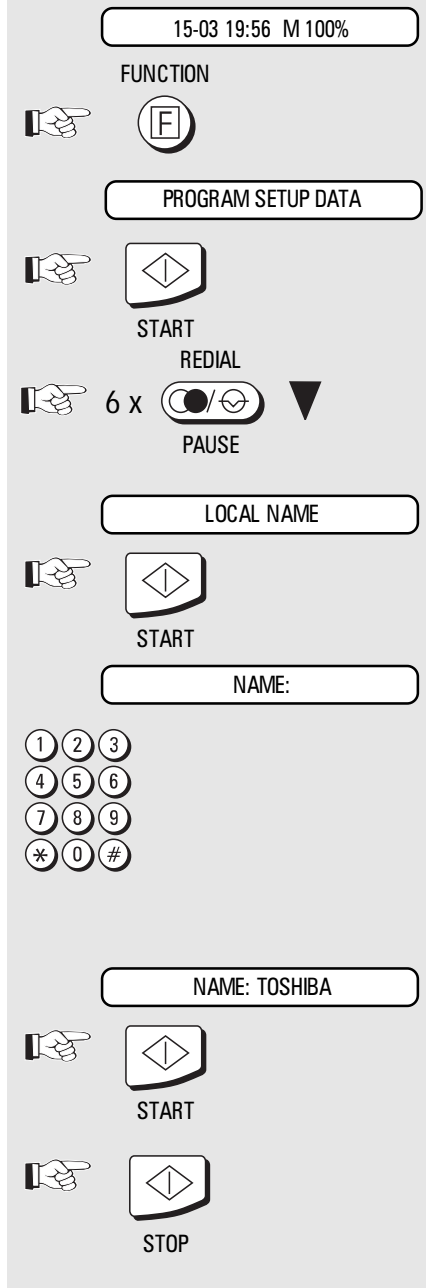

Standby mode

Start the menu

Confirm with START

Page through the menu...

...until this menu item appears

Confirm with START

Make your selection

Enter the name

Example: TOSHIBA

1 x 8 = T # 3 x 4 = I #

3 x 6 = O # 2 x 2 = B #

4 x 7 = S # 1 x 2 = A

2 x 4 = H #

Name is complete

Confirm with START

Press STOP, return to standby mode

Installation

Setting dialling method

There are two dialling methods. The pulse-dialling method is normally used in the public switched telephone network. If your fax machine is connected to a PABX, the DTMF dialling method may also be used. As the public network is modernised, this dialling method may also be used in the public network. If you are in any doubt, first try the pulse-dialling method (basic setting). If the dialling procedure fails, try DTMP dialling. However DTMF is the most efficient.

15-03 19:56 M 100%

FUNCTION

PROGRAM SETUP DATA

2 x START

PARAMETER NUMBER =

1 2 3 2 0
4 5 6
7 8 9
* 0 #

START

DIAL METHOD TONE

REDIAL PAUSE

DIAL METHOD 10PPS

START

STOP

Standby mode

Start the menu

Confirm with START (2x)

Make your selection

Enter function number

Confirm with START

Set dial method

Page through the menu...

...until you reach the desired menu item

Confirm with START

Press STOP, return to standby mode

Installation

Connection to PABX, obtaining a public line

The TF 461 can be connected not only to the public switched telephone network (public line) but also to a PABX. In this case, additional parameters have to be entered.

With PABXs, the public line is obtained in various ways:

- **Number** Dial one digit (or several digits) in order to obtain the public line
- **Earth key** Earth potential is connected to the voice wire(s) in order to obtain the public line
- **Flash key** With this method of obtaining the public line, the connection circuit is interrupted briefly.

With this method of obtaining the public line, the connection circuit is interrupted briefly.

 When the method of obtaining a public line has been entered, you must always press the key "R" before the actual number when you dial your fax partner. This is also applicable for saving the fax numbers (see [page 38](#)).

 If you have problems if your machine is connected to an extension, please read the "Comments concerning connection to PABXs" under "Further settings" ([page 61](#))

Standby mode

Start the menu

Confirm with START (2x)

Make your selection

Enter function number

Confirm with START

Set public line

Page through the menu...

Flash function
Earth key function
Code

...until you reach the desired menu item

Confirm with START

Press STOP, return to standby mode

Installation

Only with CODE setting

FUNCTION

PROGRAM SETUP DATA

2 x

START

PARAMETER NUMBER =

START

ACCESS CODE =

ACCESS CODE = 0

START

STOP

Start the menu

Confirm with START (2x)

Make your selection

Enter function number

Confirm with START

Make your selection **CODE**

Enter the code(s)
(Example: 0)

...until you reach the desired menu item

Confirm with START



Press STOP, return to standby mode

Installation



Connection to PABX, further settings

If you wish to connect your fax machine to a PABX, further settings are necessary. The following menu procedure sets default values for connecting a fax machine to PABXs. If the machine does not operate perfectly, please refer to [page 61](#) for explanations concerning connection to PABXs.

FUNCTION

 



PROGRAM SETUP DATA

 2 x 

START

PARAMETER NUMBER =





START



LINE = PUBLIC LINE

REDIAL

  ▼



PAUSE

LINE = PBX

START





START



PAUSE WAIT TONE

REDIAL



  ▼

PAUSE

PAUSE WAIT 3.0SEC

START

STOP

Start the menu

Confirm with START (2x)

Make your selection

Enter function number

Confirm with START

Current setting

Page through the menu...

...until you reach the desired menu item

Confirm with START

Enter function number

Confirm with START

Page through the menu...

...until you reach the desired menu item

Confirm with START

Press STOP, return to standby mode

Installation

Set date and time

Enter the current date and time at this point so that all details relating to date and time is correct. The internal clock of your fax machine then runs automatically - even in the event of a power failure.

15-03 19:56 M 100%

FUNCTION

PROGRAM SETUP DATA

START

REDIAL

4 x PAUSE

DATE & TIME

START

DD-MM-YY HH:MM

1 2 3
4 5 6
7 8 9
* 0 #

15.03.95 19:56

START

15-03 19:56 M 100%

Standby mode

Start the menu

Confirm with START

Page through the menu...

...until this menu item appears

Confirm with START

Make your selection **date & time**

Enter **date and time**

Example: March 15th, 19.56 hours



Input sequence: year, month,
day, hour, minute

Confirm with START

Standby mode

Reception of documents

Set standby mode

If your fax machine is connected to the PSTN or the PABX, there are four different ways of receiving documents.

Automatic reception

If the line is reserved exclusively for fax operation.



LED "reception" is lit

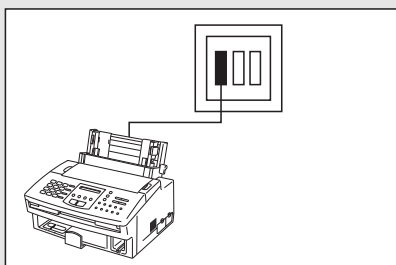

The fax machine switches over to reception as soon as the line rings (see [page 21](#)).



The fax machine is always activated, even if the call is initiated by a voice partner.

Manual reception

Refer to the parameter setting, other wise malfunktion will appear.

- **Parameter-No. 38**

Please read [page 48, 49](#).

If the line is used primarily for telephone traffic



LED "reception" off

RCV MODE = TEL

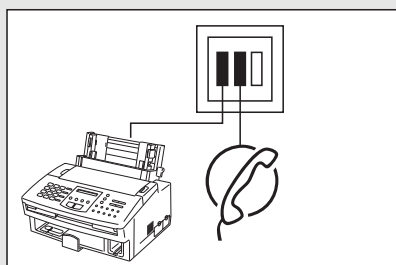

The call must be accepted manually; the fax machine is not activated when the line rings. If you wish to transmit a document, you must press the START key of the fax machine.





















Ensure that any fax calls can indeed be accepted; it is always necessary to press the START key.

Reception of documents

Manual reception (continued)

If you have connected a cordless telephone to your fax line as described on [page 4](#), you may collect a call which was destined for your fax machine. This is indicated in the form of periodic beeps. You can then use a two-digit key code (user-definable) to activate the fax machine, by remote control. You can activate or deactivate this facility:

	15-03 19:56 M 100%	Standby mode
	FUNCTION 	Start the menu
	PROGRAM SETUP DATA	
	2 x  START	Confirm with START (2x)
	PARAMETER NUMBER =	Make your selection
		Enter function number
	 START	Confirm with START
	RMT ACTIVATION OFF	Set remote reception
	REDIAL  ▼ PAUSE	Page through the menu...
	RMT ACTIVATION ON	...until you reach the desired menu item
	 START	Confirm with START
	PARAMETER NUMBER =	Make your selection
		Enter function number
	 START	Confirm with START
	ACTIVATION CODE =**	Preset key code
		Enter the 2-digit key code (Delete the preset code with the CANCEL key)
	 START	Confirm with START
	 STOP	Press STOP, return to standby mode

Reception of documents

TEL/FAX mode:

For **TEL/FAX** setting:

- **Function no. 38**, activate the TEL/FAX mode
- **Function no. 39**, ringing signals: number of ringing signals before your fax machine collects the call (1-10)
- **Function no. 36**, synthetic ringing signal: number of ringing signals (synthetic ringing tone) from the loudspeaker (1-10)

Please read [page 48, 49](#).

If the line is used for telephone and fax traffic.

LED "reception" off

RCV MODE = TEL/FAX

TEL DELAY 01

CALLING TIMES

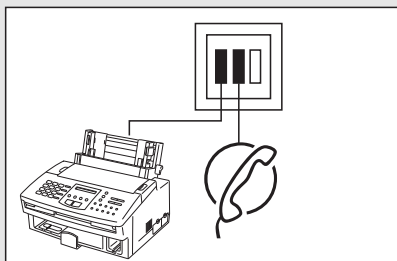

In the event of a call, the fax machine takes a fully automatic decision concerning subsequent procedures: If a caller wishes to conduct a telephone conversation, the fax machine generates ringing signal via the loudspeaker so that this call is indicated as a telephone conversation. At the same time, the caller receives an indication that the desired number is ringing.

Proceed as follows to collect the call: Lift the handset, and press the STOP key on your fax machine.

If another fax machine is attempting to reach your fax machine, your machine remains silent and automatically receives the document.



Ensure that somebody who is able to accept the call is always present in this mode. As soon as the ringer sounds, the connection is made and the caller incurs charges.

FAX/TAD mode:

For **FAX/TAD** setting:

- **Function no. 38**, activate the FAX/TAD mode
- **Function no. 44**, FAX/TAD duration: indication of the time during which the fax machine detects another fax machine (TAD timer / 1-99 sec.).

Please read [page 48, 49](#).

If the line is used with a call answering equipment

LED "reception" off

RCV MODE = FAX/TAD

FAX MONITOR TIME =

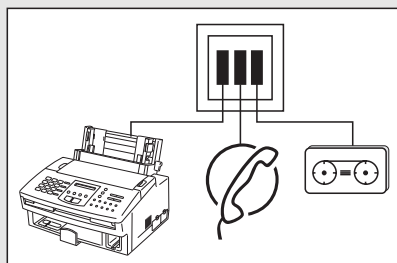

This mode enables you to receive incoming fax messages and also to answer telephone calls. There are two situations:

You are present:

Switch off the call answering equipment and collect the call at any point. If the caller is a fax machine, your fax machine will take over the call and print out the fax message.

You are absent:

Switch on the call answering equipment. The call answering equipment records all telephone calls. Your fax machine automatically receives any incoming fax messages.

Reception of documents

FAX/TAD mode: (continued)

If you wish to operate your fax machine in the FAX/TAD mode, you also have to set the TAD time. This is the period in which the fax machine reacts to a fax signal. TAD time = length of recorded message + 10 seconds.

		Standby mode
	FUNCTION	Start the menu
	2 x	Confirm with START (2x)
		Make your selection
		Enter function number
		Confirm with START
		Set TAD time
		Enter the new time
		Confirm with START
		Press STOP, return to standby mode

Switching between reception modes

Press the RECEPTION key



The MANUAL, TEL/FAX and FAX/TAD modes are all represented by the MANUAL mode. The mode which is selected depends on the setting of the functions: (see [page 16-18](#))

For **TEL/FAX** setting:

- Function no. 38, reception type = TEL/FAX: activate the TEL/FAX mode
- Function no. 39, ringing signals: number of ringing signals before your fax machine collects the call (1-10)
- Function no. 36, synthetic ringing signal: number of ringing signals (synthetic ringing tone) from the loudspeaker (1-10)

For **FAX/TAD** setting:

- Function no. 38, reception type = FAX/TAD: activate the FAX/TAD mode
- Function no. 44, FAX/TAD duration: indication of the time during which the fax machine detects another fax machine (TAD timer / 1-99 sec.).

	LED "reception" is lit	Automatic reception is activated
	AUTO RCV	Switch over the mode
	LED "reception" off	Manual reception is activated

Reception of documents

Reception reduction

Your fax machine uses A4 paper. For technical reasons, the entire length of this page cannot be used. So the fax machine reduces the length of the incoming document. This means that the received image may be slightly compressed.

In general, this effect is not problematical.

The following ratios are applicable between the original and the incoming copy (for A4 incoming document format):

Document Length (mm)	Incoming document reduction (%)	Comments
0 - 300	96	Print on one page
300 - 313	92	,
313 - 320	90	,
320 - 334	86	,
334 - 347	83	,
347 - 400	72	,
400 - 403	72	,
longer than 403	96	Print on two pages

Local copy

You can use your fax machine to make one or more copies (up to 99).

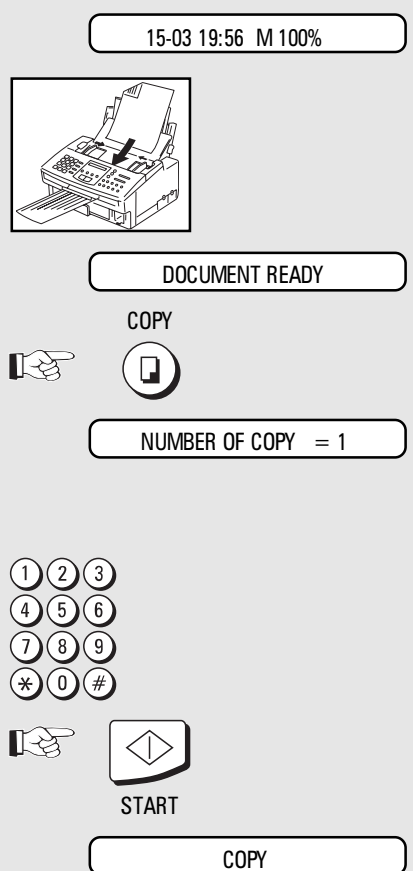

Standby mode

Load original

Remember:
Printed side face down

Document ready

PRESS COPY KEY

Make your selection
(if only one copy is to be made, please now press the START key)

Enter number of copies

Confirm with START

Copies are printed *)
The FINE resolution is used for the copy. If you wish to copy a photograph or a colour document, please select the PHOTO resolution (see [page 30](#)).

*) The copy is reduced to 96% due to technical considerations.

Reception of documents

Set call counter

If your fax machine is set to automatic reception (FAX, TEL/FAX, see [page 19](#)), it will switch on as soon as it is called. Under these circumstances, it is thus not possible for the call to be intercepted by the telephone.

However, it is possible for your fax machine to be set in such a way that - in the event of a telephone call - it is activated after a specific delay. The call counter is used for this purpose. You can use this facility to set the number of incoming calls (max. 10) before the fax machine connects to the line.

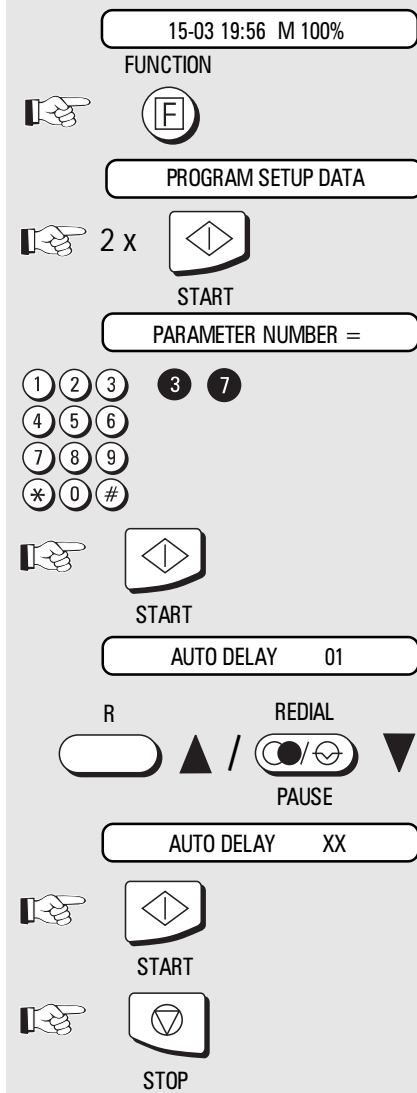

Standby mode

Start the menu

Confirm with START (2x)

Make your selection

Enter function number

Confirm with START

Set number of rings

Page through the menu...

...until you reach the desired value

Confirm with START

Press STOP, return to standby mode

Memory reception

Under certain circumstances, the machine cannot print out any further incoming copies:

- If there is no recording paper
- If there is a paper jam

In order to prevent problems with reception, the remaining pages are buffered in the memory of your fax machine. Once the problem has been solved, the document is printed out automatically.



Do not switch off the power supply as otherwise the contents of the memory will be lost.

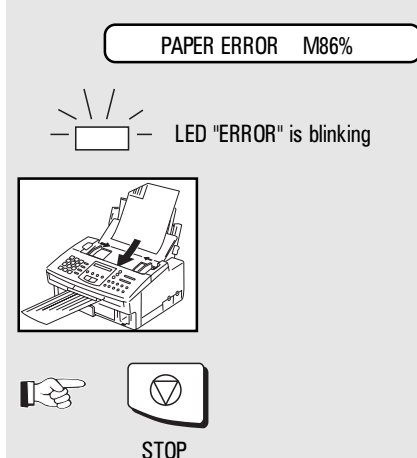

No paper, memory full

Paper out

Press STOP

Incoming copy is printed out

Transmit documents

Document format

The following table gives you an idea of which documents your fax machine can handle.

Please note:

- Documents longer than 381 mm can only be loaded manually.
- If you load several sheets at one time, they should all be of the same size and paper quality.

	Single sheet	2 or more sheets
Document size (max)	216 mm (W) x 1000 mm (L)	216 mm (W) x 382 mm (L)
Document size (min)	148 mm (W) x 105 mm (L)	
How many sheets can be loaded at one time?		stacks up to 20 sheet A4
Thickness of paper	0,06 ~ 0,15 mm	0,065 ~ 0,1 mm
Quality of paper	Uncoated on both sides	

Problem documents ...

May not feed. This applies to

- torn, wrinkled or damp pages
- folded pages or pages with holes
- transparent pages or pages with a smooth, shiny finish
- textile or metallic documents

There are two ways of avoiding this problem:
... **by photocopying or using a carrier sheet.**

Your TOSHIBA dealer can supply you with the necessary carrier sheets.

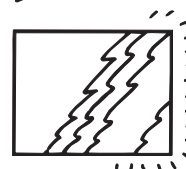
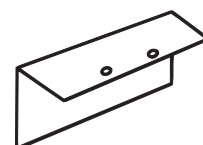

How to use carrier sheets:

Place your document face-up on the carrier sheet under the transparent cover. Carrier sheets can be used like normal documents except for one restriction: only one carrier sheet can be fed at one time.



How to load documents correctly

Remove any paper-clips, staples and similar objects before transmitting the document. Now place your documents on the document tray - up to 20 at one time - as shown.

Automatic document feeder

Most important: Only the document sheets placed facedown on the document tray can be read. If you can still read your text, you'll be sending empty pages or the back of pages!

Adjust the document guides to the edges of the sheets. After 2 seconds, your document will be automatically pulled in by about 2 cm.



If the machine pulls in more than one document insert only the first document. When this document has been pulled into the machine, place the remaining documents on top.

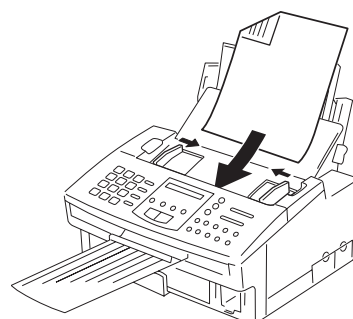

Transmit documents

Stack mode

A frequently encountered problem with fax machines is that the document tray is blocked while a document is being transmitted; no other documents can be transmitted while the fax machine is transmitting or receiving documents. This is different with your fax machine: All documents are read into the memory and are then transmitted from this memory. Incoming documents are also read into the memory before they are printed out. The advantage of this method is that the document tray is virtually always free and that documents can be transmitted almost irrespective of the transmission or receiving status of the fax machine. Each procedure is known as a job. A job may consist of one or more documents which you can transmit to your partners. A job can also be a multi-address transmission or a delayed transmission. Your fax machine is able to manage 10 such jobs. Each of these jobs is placed on a stack, from where they are processed in sequence. Your fax machine accepts jobs even while it is transmitting or receiving documents; this means that the document tray is always ready. With every procedure, the fax machine assigns a reference number (job number 01-50) to the job; this number is available via the job list (see [page 45](#)). This number can also be used for deleting a specific job.

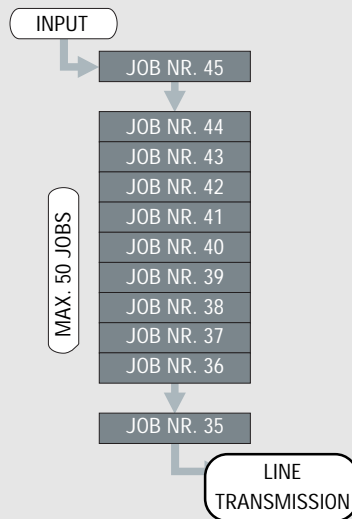

Transmit documents

Direct transmission

In the normal transmission mode your fax machine reads all documents into the memory before they are transmitted. If the documents are too large for the memory or if you have too many documents, you can also send directly from the document tray without reading the documents into the memory.



If you find that the memory is frequently too small, ask your dealer for a memory expansion!

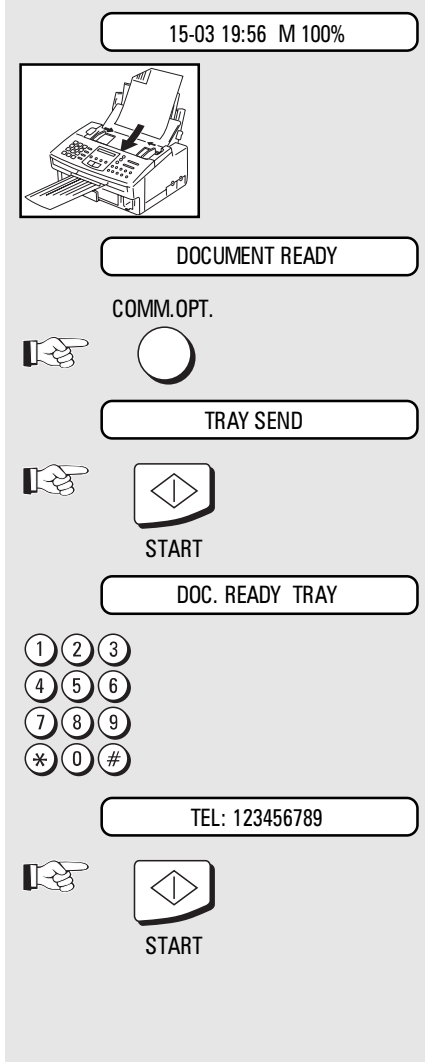

Load original

Remember:
Printed side face down

Document ready

Activate send options

Confirm with START

Enter fax number
or enter alphabet dialling or one-touch
dialling

Confirm with START

Document is transmitted

Transmit documents

Automatic fax messages

To send fax messages in the traditional manner: Insert document(s), enter the fax number and the connection is automatically established.

Your benefit: Your documents will leave the fax immediately. (Refer to [page 23](#)) If you decide to use the listening-in version (see [page 29](#)), you can also acoustically monitor the call establishment process. This is useful whenever you have problems with establishing a connection. The reason is frequently a wrong number, or a fax machine which is not ready to receive.



machine which is not ready to receive.

With the listening-in alternative, the document is **not** read into the memory; it is retained on the tray until the receiving fax machine has been contacted.



Residual memory depends on the size of the stack!



You can also enter the number first and then insert the document.



If you have entered the public line facility, you must always press the key "R" before the actual number before dialling your fax partner. This is also applicable for storing fax numbers (see [page 38](#)).

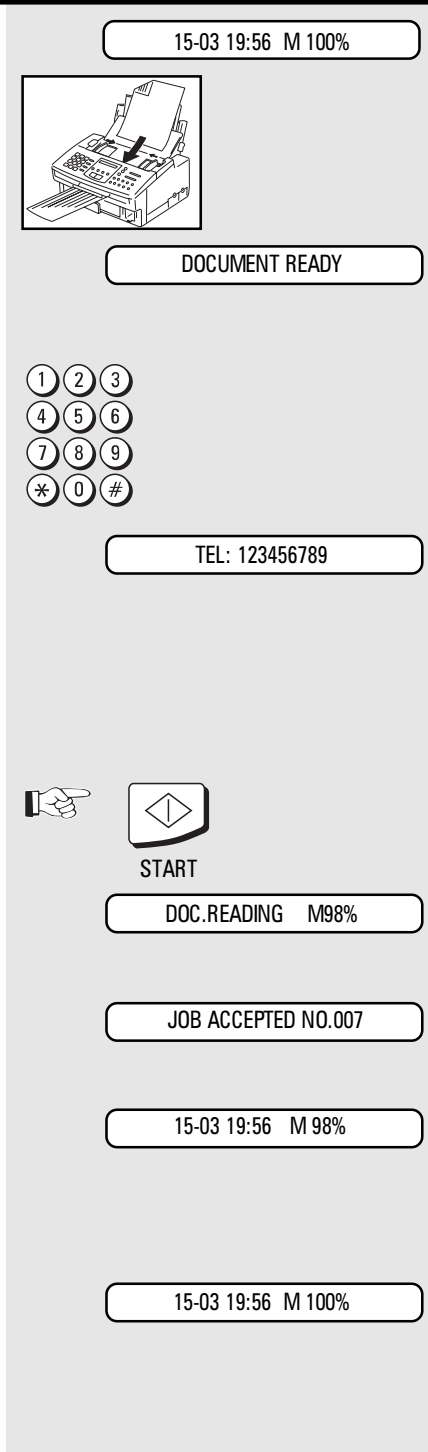

Load original

Remember:
Printed side face down

Document ready

If you have inadvertently taken the wrong document, press the STOP key before removing the document from the document feed.

Enter fax number

The entered fax number is displayed. Use the JOB CANCEL keys to make any corrections, or press the STOP key to delete the complete number. Press the STOP key again if you wish the machine to eject the document(s) without being processed.

Confirm with START

While the document is being read: current memory capacity is displayed.

When the document is read into the machine, the job number is briefly displayed.

Dialling the fax partner



The flashing LINE lamp always indicates when your fax machine is transmitting or receiving a document.

After transmission:

Change to standby display: the job is deleted from the stack memory (can be identified by means of the changed memory display).

Transmit documents

Transmission with alphabet dialling

Alphabet dialling enables you to enter a double-digit "address" instead of the (frequently-long) fax number of your partner. The real fax number is permanently stored under this "address". The alphabet dialling facility enables you to save time with frequently used fax numbers.



Please refer to [page 38](#) for details of how to save alphabet dialling numbers.

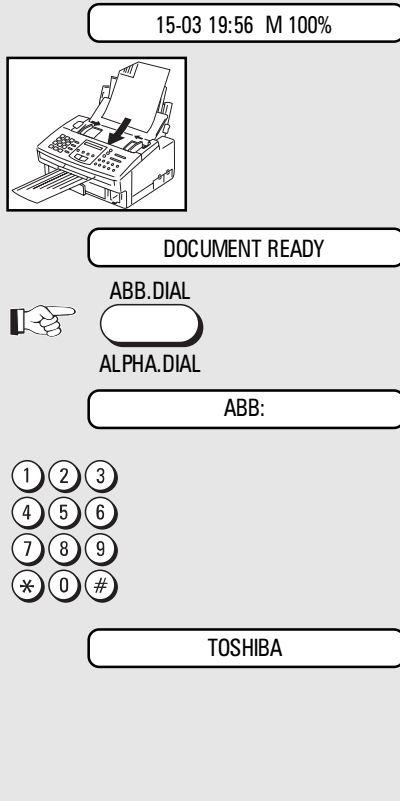

Load original

Remember:
Printed side face down

Document ready

Activate the alphabet dial facility

Make your selection: alphabet dial number

Enter the (2-digit) alphabet dial number

The name is displayed

The connection is established (for procedure, see [page 25](#), Automatic fax transmission).

Transmission with one-touch dialling

One-touch dialling provides you with a very easy method of dialling the number of your partner. You can assign any fax numbers to 8 keys. You need to press a key only once in order to reach your partner.



Please refer to [page 40](#) for details of how to store one-touch dialling numbers.

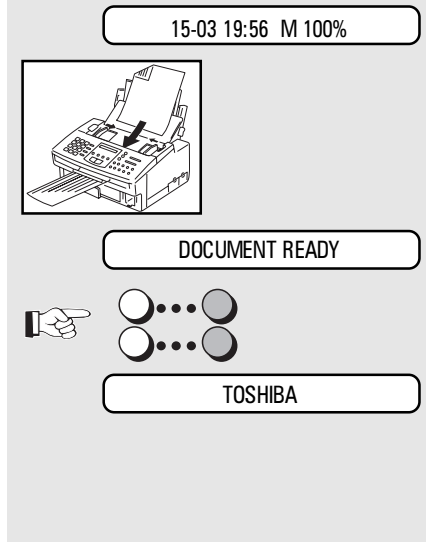

Load original

Remember:
Printed side face down

Document ready

Press a one-touch dial key

The name is displayed

The connection is established (for procedure, see [page 25](#), Automatic fax transmission).

Transmit documents

Transmission with telephone (manual transmission)

The call in this case is established with a telephone which is additionally connected to the wall socket. You can thus speak to the other party before you send the fax message.

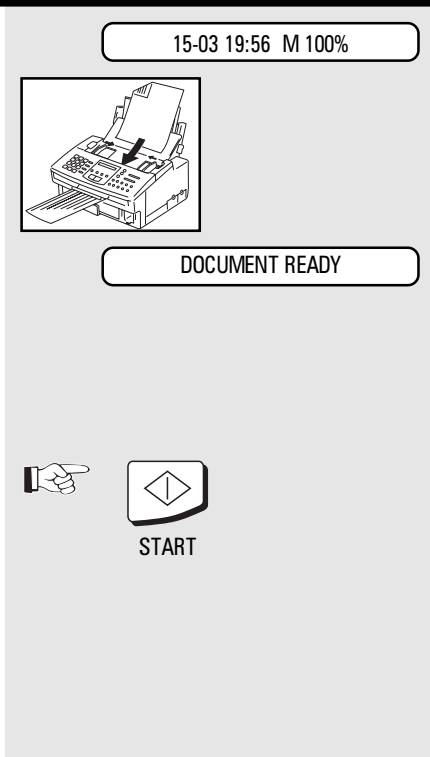

Load original

Remember:
Printed side face down

Document ready

Dialling with telephone

If you have agreed the transmission with your fax partner, or if you hear the fax tone at the other end:

Confirm with START

Transmission commences
(You can replace the handset, as the fax machine has now assumed control).

Transmit documents

Transmission with directory function

This type of dialling is similar to searching in a telephone directory. Enter the initial letter of your partner to search for the corresponding fax number in the alphabet dialling memory. This type of dialling is particularly useful if you know the name of a specific partner

15-03 19:56 M 100%

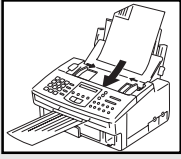

DOCUMENT READY

2 x  ABB.DIAL
ALPHA.DIAL

SELECT NAME





ANDREWS



BOND

BROWN

 
START

NO ENTRY

Load original

Remember:
Printed side face down

Document ready

Activate directory function

You can now enter the initial letter of your fax partner.
(see letter input, [page 10](#) *).
(Example: ,B")

Key „2“

The first name of the corresponding letter (here "A") is displayed.

Key „2“

Press the key "2" to display the next letter (here "B") which is stored under this key.

Use the keys „R“ and „REDIAL“ to select the desired fax partner with identical starting letters.

Confirm with START

The connection is established (for procedure, see [page 25](#), Automatic fax transmission).

*) This display appears if no name is stored under the selected letter.

Transmit documents

Monitoring

In case of transmission problems, this function is very helpful. Check dialling by this method allows you to detect wrong numbers and busy parties also.



With the listening-in alternative, the document is **not** read into the memory; it is retained on the tray until the receiving fax machine has been contacted.

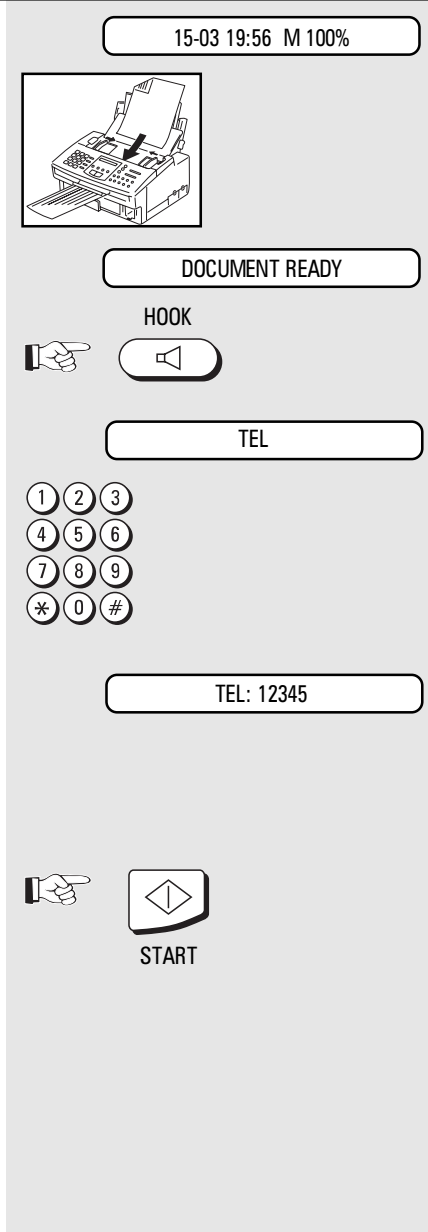

Load original

Remember:
Printed side face down

Document ready

Activates monitoring

Make your selection

Your entry

(or alphabet dial number, or one-touch dial number)

Dialling starts

If another fax machine can be heard (beep)

Confirm with START

The connection is established (for procedure, see [page 25](#), Automatic fax transmission).



If no connection is established, press the STOP key to disconnect the fax machine from the line.

Transmit documents

Set resolution

In its basic setting, your fax machine uses high resolution for transmitting or copying your documents. You can however also adjust the resolution to suit the particular documents. Use the following as a rough guide:

- STD For hand-written or typewritten documents
- FINE For documents with small type such as newspapers and diagrams
- SF For documents with very small and detailed diagrams
- GREY 64 grey stages for photographs or colour documents



Higher resolution has an impact on transmission time!



To change the resolution, press the RESOLUTION key several times. The LEDs above this key indicate the set mode:

Lamp	Mode
FINE off GREY off	Standard mode
FINE on GREY off	Fine mode
FINE on GREY on	Superfine mode
FINE off GREY on	Grey stage mode

Redial

If it was not possible for your fax message to be sent, this may be due to various reasons (please read [page 55](#)). One reason may be that the other fax machine is busy. In this case, it would make sense to call your partner again at a later time. This is done automatically by your fax; it attempts to send the fax message again approx. every three minutes.



If you have established a connection via the HOOK key, you can redial a number using the REDIAL/PAUSE key.

Transmit documents

Delayed transmission

You are able to define a certain time at which the documents will be transmitted; this enables you to overcome the problems involved with different time zones or will enable you to transmit documents at off-peak rates. The benefit of reading into the memory is, that your ADF can be used for the next transmission.

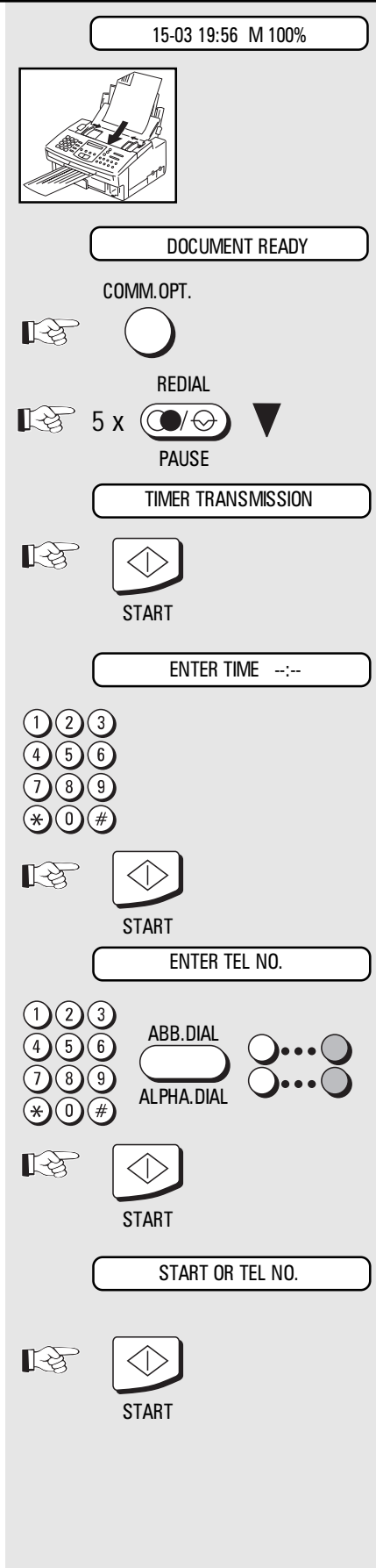

Load original
Remember:
Printed side face down

Document ready

Activate send options

Page through the menu...

...until this menu item appears

Confirm with START

Make your selection for start time

Enter start time

Confirm with START

Make your selection for fax number

Enter the fax number directly, or via alphabet dialling or via one-touch dialling

Confirm with START

Make your selection for further fax numbers (max. 20 numbers)
-or-

Confirm with START

The documents are read into the memory and sent to the various users.



Only one job can be programmed for delayed transmission.

Transmit documents

Single multi-address transmission

If you wish to send one document to several partners without spending a lot of time, this function can be used to create a group on one single occasion. The group is deleted after the procedure has been completed. Up to 20 users can be grouped together from one-touch dialling numbers, alphabet dialling numbers or standard numbers.

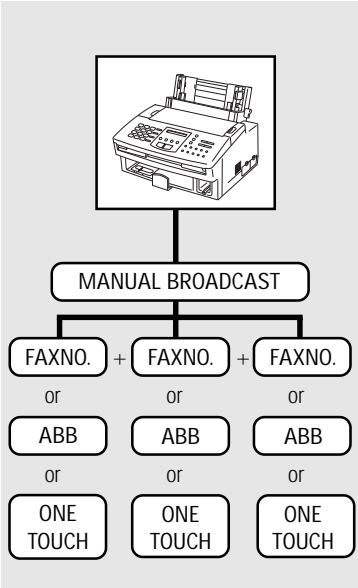

15-03 19:56 M 100%

DOCUMENT READY

COMM.OPT.

REDIAL

PAUSE

MANUAL BROADCAST

START

ENTER TEL NO.

1 2 3
4 5 6
7 8 9
* 0 #

ABB.DIAL

ALPHA.DIAL

START

START OR TEL NO.

START

Load original

Remember:
Printed side face down

Document ready

Activate send options

Page through the menu...

...until this menu item appears

Confirm with START

Make your selection

Enter the fax number directly, or via alphabet dialling, or via one-touch dialling

Confirm with START

Make your selection for further fax numbers (max. 20 numbers)

-or-

Confirm with START

The documents are read into the memory and transmitted to the individual users.



If delayed transmission has been programmed, the broadcast facility is not available.

Transmit documents

Stored broadcast

If you have a fixed group of fax partners to whom you frequently have to send broadcast fax messages, the stored broadcast facility is just what you need. You can use two methods of setting up groups of your choice. It is also possible to store four of these groups on four special keys so that a broadcast transmission can be activated at the push of a button.

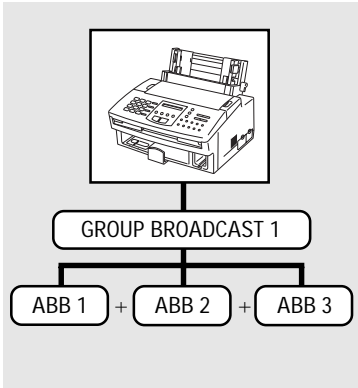

Please refer to [page 40](#) for details of how to program permanent groups.

The diagram shows a vertical sequence of events on a fax machine's display:

- A status bar at the top showing "15-03 19:56 M 100%".
- An icon of a fax machine with a document being loaded.
- A box displaying "DOCUMENT READY".
- An icon of a hand pointing to a dial key.
- A set of four circular dial keys, with the top-left key highlighted.
- A box displaying "SUPERGROUP".

Load original
Remember:
Printed side face down

Document ready

Press the one-touch dial key

The group name is displayed briefly

The connection is established (for procedure, see [page 25](#), Automatic fax transmission).

Transmit documents

Polling

A type of self-service facility enables you to fetch documents from another partner if your partner has prepared this function. "Fax on demand", i.e. obtaining information from mailboxes such as weather reports, traffic reports or stock market reports, is also possible with this function.

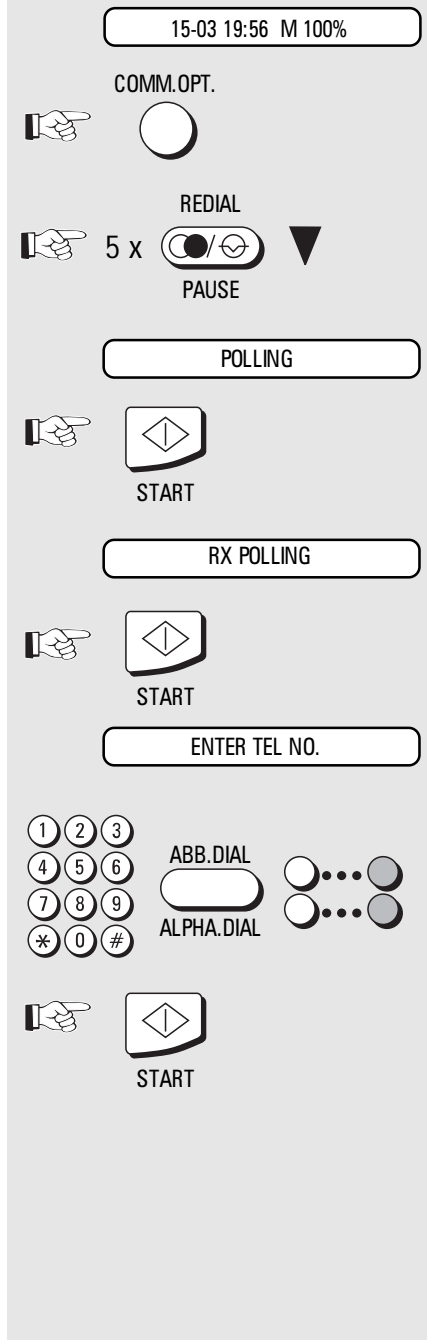

Standby mode

Activate send options

Page through the menu...

...until this menu item appears

Confirm with START

Confirm with START

Make your selection for fax number (from which a document is to be polled)

Enter the fax number via the keyboard, or via alphabet dialling, or one-touch dialling

Confirm with START

The document is polled

Transmit documents

Reserve polling

Other fax partners can poll information from your fax machine if you set up this facility with this function.

Your document which you reserve for polling is read into the memory of the machine so set the document tray is not blocked.

This reserve polling facility is unprotected. This means that any fax machine with a polling facility will be able to poll the document.

When the document has been polled, it is deleted from the memory.



Only one document can be reserved for polling

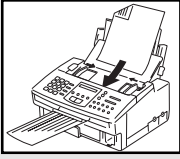

15-03 19:56 M 100%

DOCUMENT READY

COMM.OPT.

REDIAL

5 x PAUSE

POLLING

START

REDIAL

PAUSE

POLLING STANDBY

START

Standby mode

Load original

Remember:
Printed side face down

Document ready

Activate send options

Page through the menu...

...until this menu item appears

Confirm with START

Confirm with START

The document is read into the memory and is available for the next polling procedure

Transmit documents

Reduce transmission speed

Poor quality telephone lines or bad connections can cause problems. Sending and receiving problems are most common when sending documents to long distance or overseas. You can set your unit's transmission speed to 4800BPS for safer data transfer. This setting is automatically canceled after the sending session.

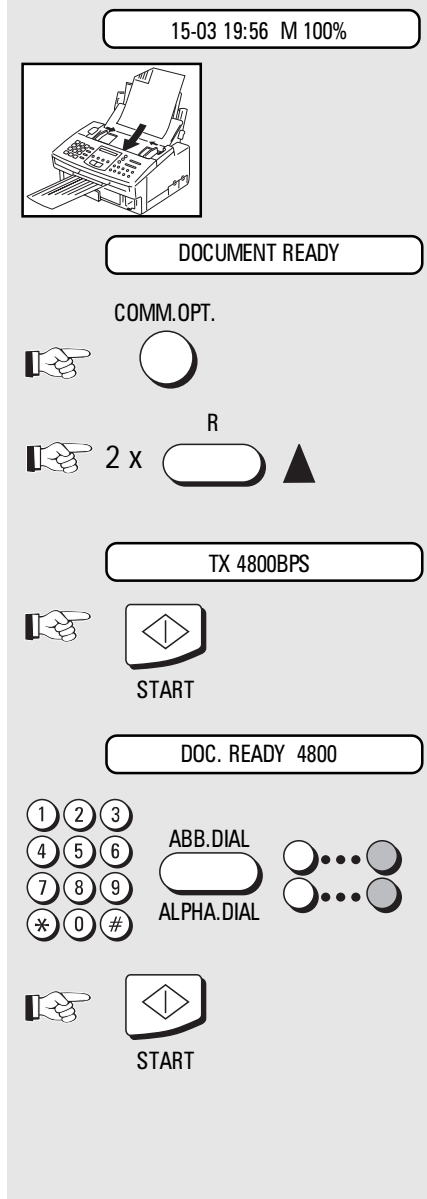

Load original

Remember:
Printed side face down

Document ready

Activate send options

Page through the menu...

...until this menu item appears

Confirm with START

Display of set mode

Enter the fax number

via the keyboard, or via alphabet dialling or one-touch dialling

Confirm with START

The connection is established (for procedure, see [page 25](#), Automatic fax transmission).

Transmit documents

Stop transmission

You may inadvertently dial the wrong partner or you may enter a wrong number. You then have to interrupt this procedure. It is possible for this procedure to be situated between other jobs. As a result of stack mode, it is possible for the current transmission not to be directly related to the actions of the operator. These procedures are deleted by „paging“ through the job stack; search for the appropriate job and delete the specific job.

As the display indicates only the job numbers and the time, it is advisable for the job list to be printed out (see [page 45](#)) in order to obtain a more precise allocation.

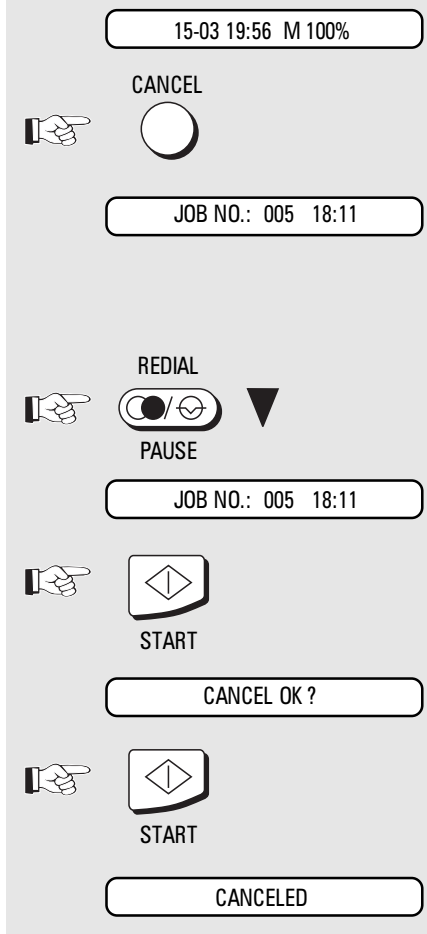
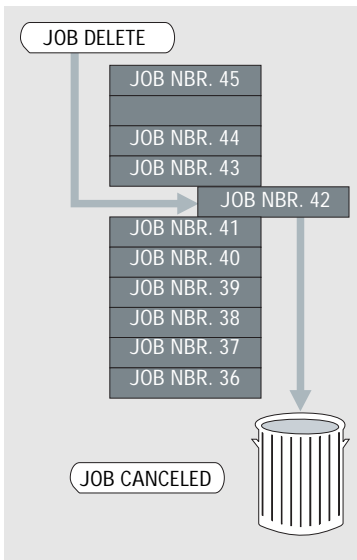

Standby mode

Activate CANCEL

The first job is displayed



The time indicated after the job number is the time at which the job was entered.

Page through the various jobs

...until you reach the desired job

Confirm with START

Are you sure?

Confirm with START

The job is cancelled

Store numbers

Alphabet dial memory

The alphabet dial facility enables you to enter a two-digit „address“ instead of the (frequently long) fax number of your partner. The real fax number is stored under this „address“. With frequently used fax numbers, the alphabet dial facility enables you to save time. 70 alphabet dial memories are available and the name as well as the number of your partner can be stored in this memory. You can use up to 15 characters of your choice in this memory.

ABB NO. 70	09154/87823 BROWN
ABB NO. 69	024/8768 EVENS
•	
•	
•	
ABB NO. 003	054/938734 IRVING
ABB NO. 002	04544/6723 MARKS
ABB NO. 001	054/376014 MILES

Use the numeric keys for entering the alpha-numeric characters. Each digit features several characters which can be activated by repeatedly pressing the corresponding key. If you have found a character of your choice, press the „#“ key to go to the next position. Use the „*“ key to go back one letter and make any corrections. Use the JOB CANCEL key to delete the left-hand character.



! Please note that you must press the „R*“ button before the actual fax number if your fax machine is connected to a PABX.

15-03 19:56 M 100%

FUNCTION

PROGRAM SETUP DATA

REDIAL

PAUSE

ENTER DIAL NUMBER

START

ENTER ABB DIAL

START

ENTER:1 DELETE:2

ENTER Go to A DELETE Go to B

Standby mode

Start the menu

Page through the menu...

...until this menu item appears

Confirm with START

Confirm with START

Decision:
Enter: Go to A
Delete: Go to B

A ENTER 1

ENTER ABB NUMBER =

START

TEL: _

START

NAME: _

Select a menu item

Make your selection for alphabet dial number

Enter alphabet dial number
Example: 01

Confirm with START

Make your selection for fax number *)

Enter fax number

Confirm with START

Make your selection for the name
(press START to skip)

Store numbers

1 2 3
4 5 6
7 8 9
* 0 #

NAME: TOSHIBA

START

PRESS OT OR START

START

ENTER ABB NUMBER =

STOP

Enter the name
(Example TOSHIBA)

T = 1 x 8 # I = 3 x 4 #
O = 3 x 6 # B = 2 x 2 #
S = 4 x 7 # A = 1 x 2 #
H = 2 x 4 #

Confirm with START

Input option: one-touch dial key (see page 26)

-or-

Confirm with START

Make your selection for the next alphabet dial number

-or-

Press STOP, return to standby mode

B DELETE

2

ENTER ABB NUMBER =

1 2 3 0 1
4 5 6
7 8 9
* 0 #

START

TOSHIBA

START

ENTER ABB NUMBER =

STOP

Select a menu item

Make your selection for the alphabet dial number to be deleted

Enter alphabet dial number

Example: 01

Confirm with START

The name is displayed

Confirm with START

Make your selection for further alphabet dial numbers to be deleted

Press STOP, return to standby mode

Store numbers

One-touch dial keys

The one-touch dial facility is a very easy method of dialling your partner. You can store fax numbers on 8 keys. You need only press one key in order to dial your partner.

It is essential that the number has already been stored under an alphabet dial number previously.

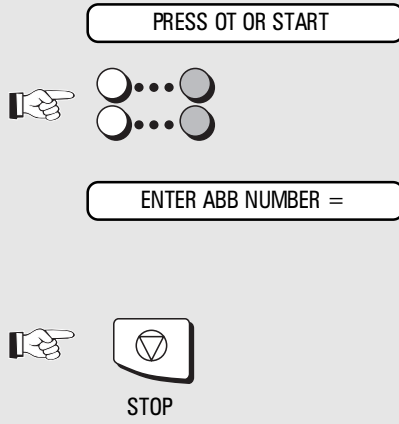
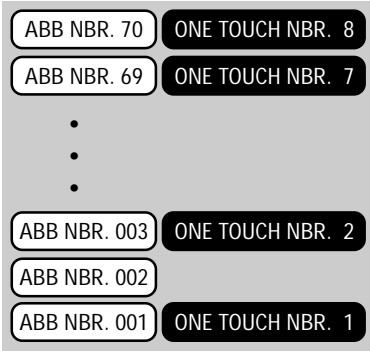

The procedure is the same as that described on [page 38](#) (alphabet dialling) If alphabet dial numbers have already been entered, simply press the START key until you arrive at this point in the menu:

Input option: one-touch dial key

Press one-touch dial key

Make your selection for the next alphabet dial number
-or-

Press STOP, return to standby mode

Group keys

If you have a fixed number of partners to whom you frequently send broadcast transmissions, the stored broadcast facility is just what you need. There are 2 methods of creating groups of your choice. You can also assign four of these groups to four special keys so that a broadcast transmission can be initiated at the push of a button. If a permanent group is to be defined, all users of a group must be already be in the alphabet dial directory.

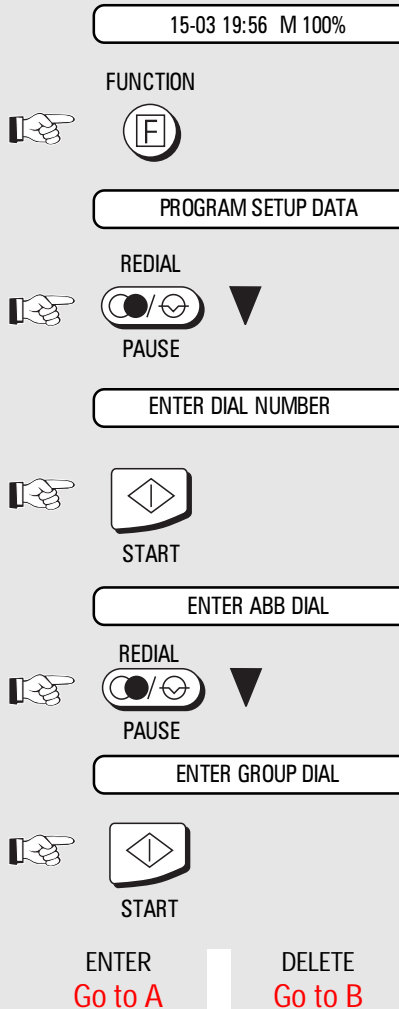
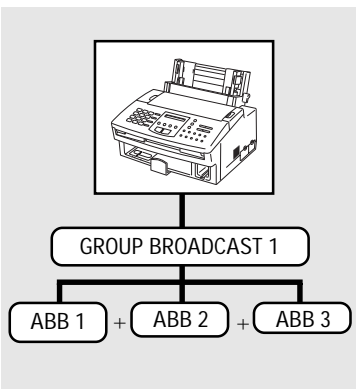

Standby mode

Start the menu

Page through the menu...

...until this menu item appears

Confirm with START

Page through the menu...

...until this menu item appears

Confirm with START

Decision:

Store numbers

A ENTER

Enter: Go to A
Delete: Go to B

 1

SELECT GROUP BUTTON





ABB:



 **START**

NAME: TOSHIBA





 **START**

ABB:

 **START**

NAME:



 **START**

 **STOP**

Select a menu item

Make your selection for the group button

Press the desired group button

Make your selection for the alphabet dial number to be assigned to the group

Enter the alphabet dial numbers

Confirm with START

The corresponding name is displayed

Confirm with START

Make further selection of alphabetdial number to be assigned to the group

-or-

Confirm with START

Make your selection group name

Enter the group name
(Example of entry: see [page 10](#))

Confirm with START

Press STOP, return to standby mode

Store numbers

B DELETE

 2

SELECT GROUP BUTTON



TOSHIBA

START

DELETE OK ?

START

STOP

Select a menu item

Make your selection for the group button to be deleted

Press the desired group button

The corresponding name is displayed

Confirm with START

Are you sure?

Confirm with START

Press STOP, return to standby mode

Report prints

Activate printing report

Not all reports are printed out automatically; they have to be requested specially. These lists can provide information concerning the current state of the fax machine. The following reports can be printed:

- Transmission report
- Multitransmission report
- Transmission and reception journal
- ABB Number list
- Group list
- Function list
- List of jobs in memory

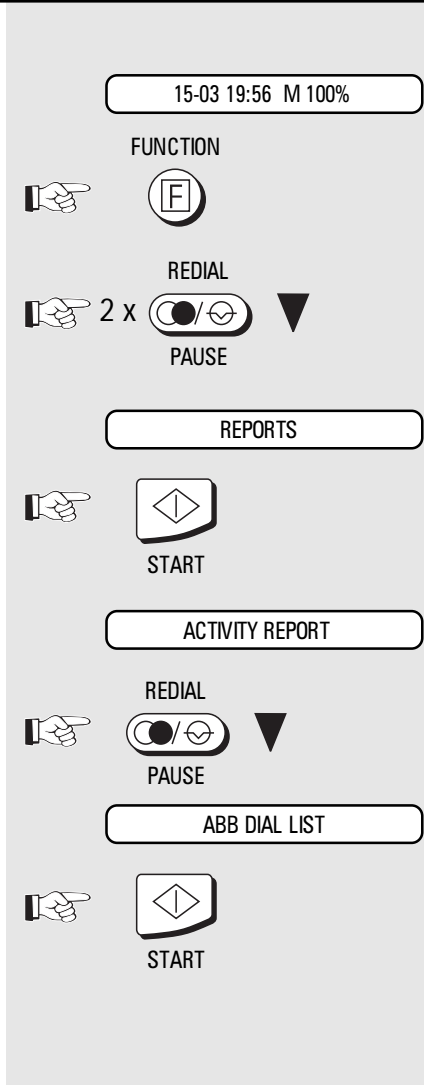

The lists are retrieved as follows:

Standby mode

Start the menu

Page through the menu...

...until you reach the desired menu item

Confirm with START

The first menu item is displayed

Page through the menu...

...until you reach the desired menu item

Confirm with START

The list is printed out

Transmission report

This report can be printed after every transmission or in the event of a defective transmission. It provides information about the most important transmission data. Please refer to [page 44](#) for switching ON/OFF.

*** TRANSMISSION REPORT ***		
31-10-95	01:19	ID:+44193212345678
		TEG FT TF461
JOB NBR.	-----	001
START TIME	-----	01:19
ID No.	-----	111
RESOLUTION	-----	HALF TONE
TOTAL PAGE	-----	00
MACHINE ENGAGED	-----	00'28
INFORMATION	-----	OK
ERROR PAGE	-----	

Report prints

Transmission and reception journal

Your fax machine will record messages which you transmit or receive in the form of transmission and reception journals. These lists are printed out automatically after every 40 transmissions or receptions or at your request.

The journal also informs you of the number of scanned pages and the remaining contents in the ink cartridge. Five marks means full, one mark indicates storage.

*** ACTIVITY REPORT ***							
30-11-95 15:02		ID: +44 1932 12345678					
FAX/TELECOM MKTG							
INK LEVEL: ■■■■							
SCAN PAGE: 000091							
No.	DATE	TIME	IDENTIFICATION	PAGE	TIME	INFO	JOB No.:
①	②	③	④	⑤	⑥	⑦	⑧
TRANSMISSION							
01	11-08	08:00		00	00'00	008	001
02	11-10	09:17	12345678	00	00'35	STOP	002
03	11-00	09:24	987654321	01	00'30	OK	ECM 004
RECEPTION							
04	11-08	14:17	+04965321	01	00'36	OK	ECM
05	21-08	06:00		00	00'45	011	
06	15-10	14:30	5432101	04	01'58	OK	ECM

To activate printout press JOURNAL button.

- ① NO:
Lists the communications in the order they occurred.
- ② DATE:
Date
- ③ TIME:
Start of transmission
- ④ IDENTIFICATION:
Number pf faxpartner
- ⑤ PGS:
Gives the number of pages per transmission or reception.
- ⑥ DURATION:
Time of transmission
- ⑦ INFO:
result of transmission
- ⑧ JOB-NO.:
Current job number

OK	Group without any errors
OK_ECM	ECM
STOP	the operator has stopped the transmission
001-360	description of the transmission error (see page 55)
OK-PC OK PEC	transmission as PC Fax
OK ROC	Comline transmission

Report prints

The multitransmission report

After a broadcast transmission (group dialling), the machine prints out a list of fax partners who have been reached or who have not been reached by group dialling. This list is always printed out when group dialling has been completed.

Number list

This list contains all numbers and corresponding names in the alphabet dial memory. The list also sets out the assignation of the various one-touch dial keys.

```
*** ABBRIVATED DIAL LIST ***  
  
01-18-00 01:16 ID: +44 1932 12345678  
TOSHIBA TF461  
  
No. OT No. NAME TELEPHONE NUMBER  
01 OT01 ALBRECHT 01010101  
02 OT02 BAUER 02020203  
03 OT03 BLUME 03030303  
04 OT04 MEIER 04040404  
05  
06
```

Group list

This is a list of the alphabet dial numbers allocated to the particular groups.

```
*** GROUP LIST ***  
  
01-18-00 01:18 ID: +44 1932 12345678  
TOSHIBA TF461  
  
GROUP1 NAME: SUPER  
No. ENTRY NAME TELEPHONE NUMBER  
01 ABB01 ALBRECHT 0123456  
02 ABB02 BAUER 6543210  
03 ABB03 BLUME 987654321  
  
GROUP2 NAME:  
No. ENTRY NAME TELEPHONE NUMBER  
01  
02
```

Jobs in progress

This list indicates which jobs are still stored by the fax machine or which jobs still have to be progressed. This information may be useful if you have stored any urgent jobs or if you wish to delete a particular job.

```
*** PENDING JOBS LIST ***  
  
01-18-00 01:15 ID: +44 1932 12345678  
TOSHIBA TF461  
  
JOB No. CONTENTS TIMER ACCEPT REMOTE TELEPHONE NUMBER /NAME  
003 TRANSMISSION 16:14 OT02 BAUER  
004 BROADCAST 16:15 GROUP1 SUPER  
007 POLLING STANBY 16:21
```

Report prints

The function list

This list provides information concerning all settings of the fax machine. They correspond with the settings which you have made. Keep this list for any service work which may be necessary.

		*** OPTIONS REPORT ***	
01-18-00 01:21		ID: ++44 1932 12345678	
		TOSHIBA TF461	
USER OPTIONS			
No.	CONTENTS	51	NOT USED
01	ECM ON	52	NOT USED
02	CONFIRMATION ON	53	NOT USED
03	NOT USED	54	NOT USED
04	HEADER PRINT ON	55	PAPER SIZE A4
05	RECEIVE FOOTER ON	56	DEFAULT RES. STD
06	XMT SPEED 9600	57	COPY REDUCT. 96%
07	RCV SPPED 9600	58	NOT USED
08	NOT USED	59	NOT USED
09	NOT USED	60	NOT USED
10	NOT USED	61	DATE DD-MM-YY
11	NOT USED	62	LANGUAGE ENGLISH
12	NOT USED	63	SCAN CONT. NORMAL
13	RDC ACCEPTANCE	64	INK SAVE MODE OFF
14	RDC CENTER ID	65	RX REDUCTION
15	NOT USED	66	NOT USED
16	NOT USED	67	INK END DITECT ON
17	NOT USED	68	BIDIRCT. PRINT ON
18	NOT USED	69	NOT USED
19	NOT USED	70	NOT USED
20	DIAL METHOD 10PPS		
21	REDIAL TIMES 05		
22	REDIAL INT. 2 MIN		
23	TRAIN INT. 5 MIN		
24	BUSY TONE		
25	INIT WAIT 3 SEK		
26	PAUSE WAIT 3 SEK		
27	ACCESS OFF		
28	ACCESS CODE = 1		
29	NOT USED		
30	NOT USED		
31	NOT USED		
32	NOT USED		
33	NOT USED		
34	NOT USED		
35	NOT USED		
36	CALLING TIMES 04		
37	AUTO DELAY 01		
38	RCV MODE= TEL		
39	TEL DELAY 05		
40	NOT USED		
41	RMT ACTIVATION OFF		
42	ACTIVATION CODE = **		
43	DEACTIVATION CODE = ##		
44	FAX MONITOR TIME =35		
45	SILENT DETECTION =08		
46	PC TRANSFER DEF. OFF		
47	NOT USED		
48	NOT USED		
49	NOT USED		
50	NOT USED		

Advanced settings

Functions

The functions of your fax machine enable you to customise the settings of the various procedures. You can use the function list (see [page 46](#)) to print out the current status of the various functions.

The following illustrates how you can change the various functions:

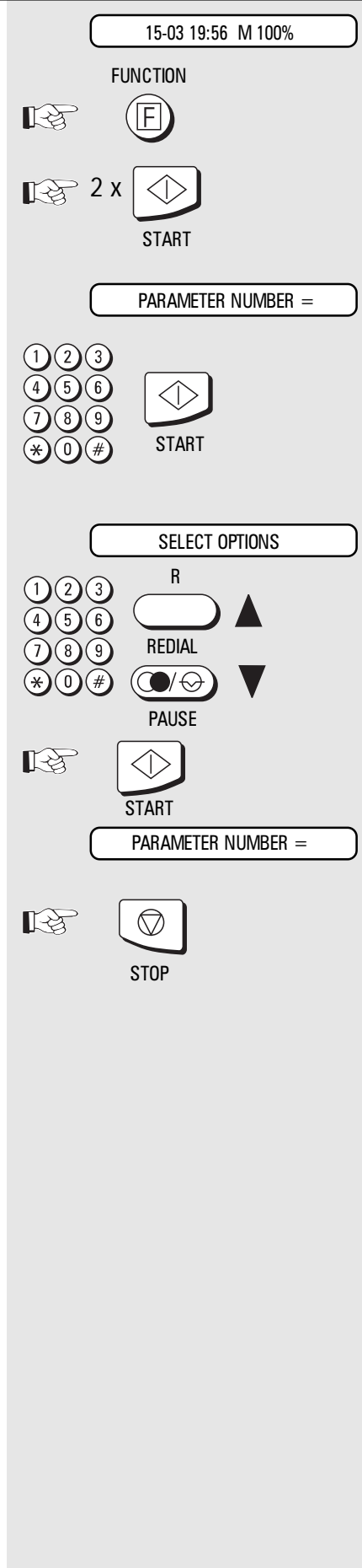

Standby mode

Start the menu

Confirm with START (2x)

Make your selection for the function number

Enter function number

and

Confirm with START

The function is displayed

Change the value of the function, depending on the particular type, by paging or by entering a new figure via the numeric keypad

Confirm with START

Input further data

-or-

Press STOP, return to standby mode

Advanced settings

The following functions are available:

Function no.	Function	Description
01	ECM	Error correction (ECM) is as follows: ON: Activated OFF: Deactivated
02	TRANSMISSION REPORT	Transmission report is produced: ON: After every transmission OFF: Only when a transmission error occurs
04	HEADER PRINT	ON: Is transmitted OFF: Is not transmitted
05	RECEIVE FOOTER	ON: Is printed OFF: Is not printed
06	XMT SPEED	Preset transmission speeds, transmission 9600 BPS 4800 BPS 7200 BPS 2400 BPS
07	RCV SPEED	Preset transmission speed, reception 9600 BPS 4800 BPS
13	RDC ACCEPTANCE	Session is possible: ON: always OFF: not allowed
14	RDC CENTER ID	A additional password can be stored to have better security.
20	DIAL METHOD	DTMF PULSE DIALLING
21	REDIAL TIMES	Number of redial attempts if transmission is not successful 02 2 times ~ 10 10 times
22	REDIAL INT.	Period between redial attempts if transmission is not successful 30 SEC 30 seconds ~ 1 MIN 2 MIN 3 MIN 10 MIN 20 MIN 20 minutes
23	TRAIN INT.	Period between redial attempts if line is busy 1 MIN 1 minute ~ 10 MIN 10 minutes
25	INIT WAIT	Type of connection at start of dialling procedure PUBLIC LINE Dialtone is checked EXTENSION Dialling procedure starts after 3 sec. delay DIAL AFTER 4.0 SEC Dialling procedure starts after 4 sec. delay ~ DIAL AFTER 6.0 SEC Dialling procedure starts after 6 sec. delay

Advanced settings

Function no:	Function	Description
26	PAUSE WAIT	<p>Dialling procedure after pause button TONE CHECK Number dialled when dialtone is received</p> <p>PAUSE BUTTON DIAL PAUSE 3.0 SEC Number dialled after pause of 3 sec. ~ DIAL PAUSE 6.0 SEC Number dialled after pause of 6 seconds</p>
27	ACCESS OFF	<p>Procedure for obtaining public line NO PUBLIC LINE PUBLIC LINE FLASH Flash- Function PUBLIC LINE EARTH KEY Earth key- Function PUBLIC LINE DIGIT Public line obtained via code</p>
28	ACCESS CODE	Enter a (max.) 4-digit code for obtaining public line
36	CALLING TIMES	<p>Number of synthetic ring signals set in the TEL/FAX mode 1 SYNTH. RING TEL/FAX 1 ring ~ 10 SYNTH. RINGS TEL/FAX 10 rings</p>
37	AUTO DELAY	<p>Number of rings before the fax machine connects to the line in the automatic receive mode (AUTO lamp is lit) 1st RING ~ 10th RING</p>
38	RCV MODE =	<p>Receive type in manual mode (AUTO lamp off) TEL purely manual mode TEL/FAX TEL/FAX mode FAX/TAD FAX/TAD mode</p>
39	TEL DELAY	<p>Number of rings before the fax machine connects to the line in the manual receive mode (AUTO lamp off). Effective only in the TEL/FAX mode  1 RING 1 ring ~ 10 RINGS 10 rings</p>
41	RMT ACTIVATION	<p>Activate the fax machine with a DTMF remote control code ON Enabled OFF Disabled</p>
42	ACTIVATIONCODE =	Enter the sequence of characters to be used as the remote control code
43	DEACTIVATION CODE	<p>Enter the sequence of characters to be used to disconnect the fax machine from the line. *Not in all countries.</p>

Advanced settings

Function no:	Function	Description
44	FAX MONITOR TIME =	Period during which the fax machine can detect another fax machine (in FAX/TAD mode)
45	SILENT DETECTION =	Minimum length of pause in speech before fax machine switches into the FAX mode (with FAX/TAD mode)
46	PC TRANSFER	ON OFF
55	PAPER SIZE	Paper sizes for PC printer operation: A4 DIN A4 size LETTER Letter size LEGAL Legal size
56	DEFAULT RES	Preset resolution STD Standard resolution FINE Fine resolution
57	COPY REDUC.	Reduction for copy OFF 100% 96% 92% 90% 86% 83% 72%
61	CALENDAR	Format of date in display and in the lists (example: March 15th, 1995) YY-MM-DD95-03-15 DD-MM-YY 15-03-95 MM-DD-YY03-15-95
62	LANGUAGE	Choice of language
63	SCAN CONTRAST	Contrast setting for scanning BRIGHTER Low coverage on document NORMAL Normal coverage on document DARKER High coverage on document
64	INK SAVE MODE	Saving mode is ON enabled OFF disabled
65	RX REDUCTION	Printout of received document reduced: AUS fixed 90% AUTO variable, 96% to 72%
67	INK END DETECT	ON Documents printed out despite empty ink cartridge, until the last drop of ink OFF When the ink cartridge is empty, the printer stops and displays an error message
68	BIDIRCT. PRINT	Bidirectional (two-way) printing ON OFF

Advanced settings

Connection to PABX

If the TF 461 is connected to a PABX, the functions have to be modified. The standard setting for this case is described starting on [page 7](#). If any problems or malfunctions occur, please consider the following items; you may have to discuss these items with the operator of the PABX:

- Does the PABX have public line capability?
- Does the PABX have DDI capability?
- Have you entered the "*" key before the actual fax number?
- How is the public line obtained (earth key, flash, number)?
- What dialling method is used (pulse-dialling, DTMF dialling)?

- Is function 25 set to EXTENSION?
- Is function 26 set to TONE CHECK PAUSE BUTTON*?
- Is the correct dialling method set in function 20?
- Has the correct method of obtaining a public line been set in function 27?
- Have the correct codes for obtaining a public line been set in function 28 (if the public line is obtained via a code)?

*) Alternatively, you can set function 26 to 4 seconds.

Receive footer on/off

As proof of the date on which the document is received, your fax machine can print the local date and time as an additional line on the received document. If this facility has been activated, the receive footer is printed at the bottom of the received document.

The diagram illustrates the sequence of button presses on the fax machine's control panel to set the 'RECEIVE FOOTER' to 'OFF'. It starts with a display showing '15-03 19:56 M 100%'. The user presses the 'FUNCTION' key (marked with 'F'). The display then shows 'PARAMETER NUMBER ='. The user enters '05' using the numeric keypad. The display shows 'RECEIVE FOOTER OFF'. The user presses the 'START' key (marked with a diamond symbol). The display shows 'RECEIVE FOOTER OFF'. The user presses the 'REDIAL' key (marked with a circle and slash symbol). The display shows 'RECEIVE FOOTER OFF'. The user presses the 'START' key (marked with a diamond symbol). The display shows 'RECEIVE FOOTER OFF'. Finally, the user presses the 'STOP' key (marked with a circle and slash symbol).

Standby mode

Start the menu

Confirm with START
(press 2x)

Make your selection for the function
number

Enter function number

Confirm with START

Change the value of the function

Confirm with START

Press STOP, return to standby
mode

Advanced settings

Change speaker volume

If you listen into a fax transmission process, the call establishment procedure is relayed via the built-in speaker. This means that you can also listen to the actual call establishment process. The volume can be adjusted as follows:

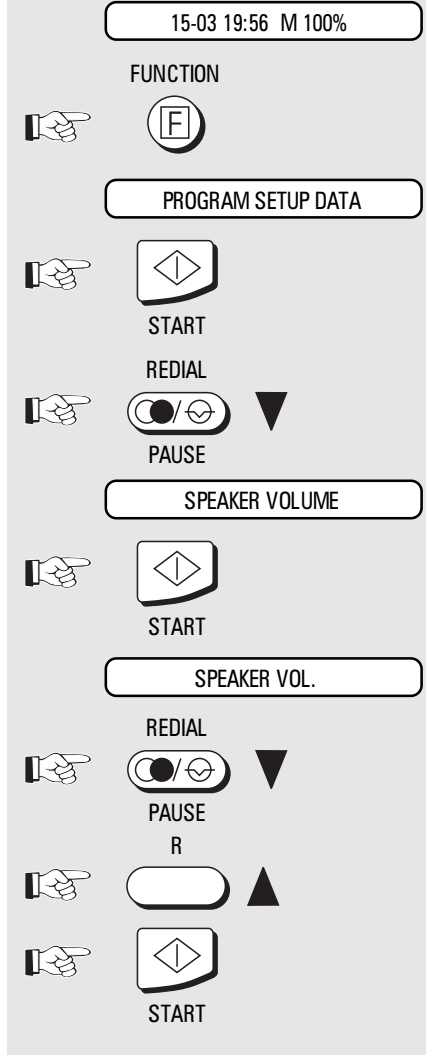

Standby mode

Start the menu

Confirm with START

Page through the menu...

...until you reach the desired menu item

Confirm with START

Current volume is displayed and indicated acoustically















Change the volume

Confirm with START

Advanced settings

Adjust ringing tone/key beeps

The volume of the ringing signal (synthetic ringing) in the TEL/FAX mode can be adjusted as follows. This setting also affects the key beep. No beeps are generated if the volume is set to minimum.

	15-03 19:56 M 100%	Standby mode
	FUNCTION 	Start the menu
	PROGRAM SETUP DATA	
	 START	Confirm with START
	REDIAL  ▼	Page through the menu...
	PAUSE	...until you reach the desired menu item
	RINGER VOLUME	
	 START	Confirm with START
	RINGER VOL.	The current volume is displayed and indicated acoustically
	REDIAL  ▼	Adjust the volume
	PAUSE	
	R  ▲	
	 START	Confirm with START

Advanced settings

Set transmission report output

This report can be printed after every transmission or only for errored transmissions. It provides information concerning the most important transmission data.

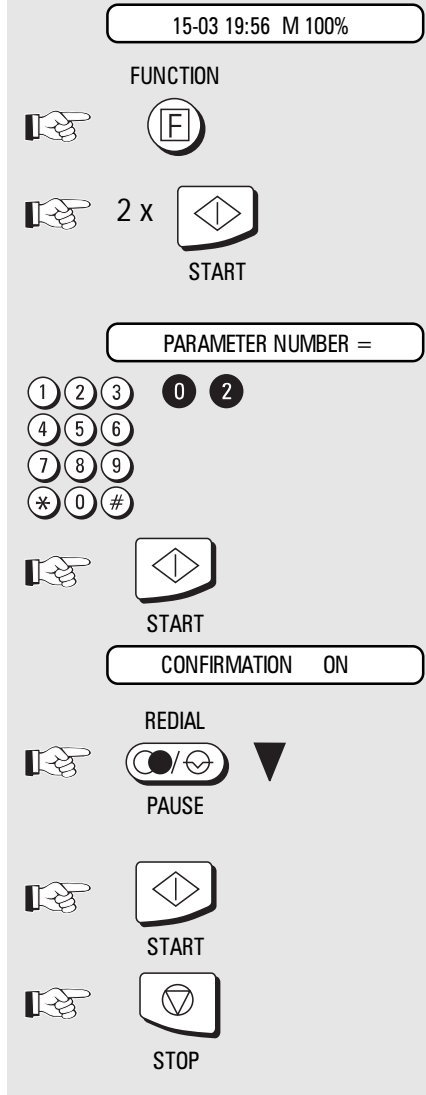

Standby mode

Start the menu

Confirm with START
(2x)

Make your selection for the function number

Enter function number

Confirm with START

Current status

Change the status as follows
 ON Transmission reported printed after every transmission
 OFF Transmission report printed only for errored transmissions

Confirm with START

Press STOP, return to standby mode

Possible problems

Error codes in journal

The display message transmission error is explained by the indicated error code. The same code is shown also in the journal and transmission report.



Press STOP to clear error messages.

Code Nummer	Cause	How to correct
STOP	The transmission is interrupted by the stop button.	Try again
OK	The document has been transmitted without any errors.	This is how it should be
001	Top cover or rear cover open	Close all parts
002	Paper jam or document too long. Is the memory full? Ask your dealer for a memory extension.	Remove the document. See also page 59 Send the document from the document feed
003	Recording paper jam or recording paper cassette is empty	Remove jammed paper or load new paper without switching off the machine, see page 59
005-011	Line error	Repeat transmission, try switching over to 4800 BPS.
014	Printing error	Check toner, process unit and paper transport
020	Errors on the line mean that parts of the document are difficult to read; however, the document is transmitted completely.	No special measures necessary. If this frequently occurs with one particular fax partner, switch over to 4800 BPS.
100-103	Line error	Repeat transmission, try switching over to 4800 BPS.
104-106	Unsuccessful polling	An incorrect password has been used, or no document was loaded for polling
111	Mailbox transmission	An attempt has been made to transmit a document to a box or relay. Check whether a TF 851 is installed at the far end.
112-123	Line error	Repeat transmission, try switching over to 4800 BPS.
127	The other party's fax machine is not compatible	Connect the other party and check compatibility
128-156	Line error	Repeat transmission, try switching over to 4800 BPS.
353-354	A remote control error occurs	Consult your dealer

Possible problems

Error messages in the Display

Your fax machine reports an operating error or fails to perform the required function. Before you make an unnecessary call on your service technician, take your time and see if you can help yourself. This checklist will help you recognise and eliminate errors.

Display	Cause	Corrective action
DOCUMENT JAM	Documents are jammed in the document tray.	Press STOP key and remove the paper
Paper error M100%	No recording paper, or recording paper has not been pulled into the machine correctly.	Read the instructions on page 5 .
Check Cartridge M100%	There is no ink cartridge, or the ink cartridge has not been inserted correctly.	Insert the cartridge correctly. See page 5 .
Ink low S 100%	The ink cartridge will soon be empty.	Contact your Toshiba dealer to order a new ink cartridge.
Ink empty M 80%	The ink cartridge is empty	Replace the cartridge. Pay attention to the instructions in the memory display. Do not switch off the fax machine!
No document	No document present	The action requires a document
PC comm. error M100%	Communication to the PC has failed	Try to remedy by pressing the STOP button
System error xxx	The fax machine has malfunctioned	Contact your TOSHIBA dealer
comm. fx xxx	The fax machine has malfunctioned	Attempt to clarify the problem using the following pages.

Possible problems

Transmission problems	Your fax machine reports an operating error or fails to perform the required function. Before you make an unnecessary call on your service technician, take your time and see if you can	help yourself. This checklist will help you recognise and eliminate errors.
Problem	possible causes and solutions
Your document is not automatically pulled into the feeder.	<p>Your machine displays an error.</p> <p>The display is blank.</p> <p>Document size or thickness of paper are not acceptable.</p> <p>The operator control panel is not firmly locked.</p>	<p>If the display gives an error message, clear the fault and delete the display with STOP.</p> <p>Check there is power on the machine. The machine must be switched on (see page 4).</p> <p>Use acceptable documents only (see page 22).</p> <p>Close the cover. It should be firmly locked in place on both sides.</p>
The line LED does not flash when you press the START button	You replaced the receiver before pressing START.	Try again. Replace the receiver only when you have pressed START.
The document is damaged during sending or copying.	<p>Document format or paper thickness not as specified.</p> <p>The document guides are not properly adjusted to the paper size.</p>	<p>Use acceptable documents only (see page 22).</p> <p>Adjust the document guides accordingly.</p>
Your fax machine performed transmission correctly but the message was not received by the receiver.	The other machine is out of paper.	Ask the receiver to put paper in his machine.
The receiver received a blank sheet instead of the document sent.	You loaded your document in the machine with the image face-up.	Send your document again: the image must be face-down on your document feeder.
The receiver reports: The document transmitted is difficult to read.	<p>Your machine's document reader is dirty or damaged.</p> <p>RESOLUTION and CONTRAST are not set correctly.</p> <p>The telephone connection is poor.</p>	<p>Make a copy of your document on your fax machine (see Ppage 20). If your copy is also difficult to read, clean the document reader.</p> <p>Make a copy on your fax machine (see page 20) and adjust the settings to your document. You can also improve document quality: By making the print on the photocopy darker, enlarging or reducing. (see page 30/31). Then send again.</p> <p>Redial. You may get a better connection.</p>
Abbreviated or one-touch dialling do not work.	Abbreviated or one-touch dialling number is not correctly stored.	Check and correct stored numbers (see page 38).
No dial tone is heard when handset is off-hook.	<p>The telephone is not correctly connected.</p> <p>The fax machine is not correctly connected.</p>	<p>Check that your telephone is connected correctly to the socket (see page 4).</p> <p>Plug the connecting cable of your fax machine into the socket (see page 4).</p>
Your call does not arrive although you have dialled the correct number.	<p>Your fax machine has been set to the wrong dialling mode.</p> <p>If you are connected to a PABX: You have set the wrong line type.</p> <p>Your fax machine is not connected to the PSTN.</p>	<p>Switch to the correct dialling procedure: DTMF or pulse-dialling (see page 11).</p> <p>Set the line types to EXTENSION (see page 12).</p> <p>Plug the connecting cable of your fax machine into the socket (see page 4).</p>

Possible problems

Receiving problems

Your fax machine reports an operating error or fails to perform the required function. Before you make an unnecessary call on your service

technician, take your time and see if you can help yourself. This checklist will help you recognise and eliminate errors.

Problem

possible causes ...

... and solutions

You press START to receive a document. But you receive nothing.

- Your have an error displayed.
- The fax machine is not correctly connected.
- The display is blank.
- There is still a document in the feeder.
- Your fax machine is set in manual receiving mode and you replaced the handset before pressing START.
- The operator control panel is not closed.

- If the display shows an error message, eliminate the fault and delete the display with STOP.
- Check the wiring. See [page 4](#).
- Check there is power to the machine. The machine must be switched on (see [page 4](#)).
- Press STOP and remove the document.
- When receiving the next fax, be sure to replace the handset only after you have pressed START.
- Close the cover. Both sides of the cover must be firmly locked in place.

Your recording paper is not fed out.

The recording paper in your machine is jammed.

Remove the jammed paper (see [page 59](#)).

The document received is difficult to read.

- Document quality is poor.
- The telephone connection is poor.

- Ask the sender to reset the resolution and contrast or improve the quality of the document e.g. by making the print on the photocopy darker, enlarging or reducing. Then have it send again.
- Ask the sender to transmitt the document again (see [page 6](#)).

You receive a completely blank document.

The sender made a mistake when loading the document.

Check whether the sender loaded in the correct manner.

The document received is partially printed.

The operator control panel of your fax machine is not closed properly on both sides.

Close the cover. Both sides of the cover must be firmly locked in place.

You can send fax messages without any problem, although you cannot receive any.

Receiving protection is activated.

Switch off receiving protection (see [page 17](#)).

Possible problems

Remove paper jam in the document feed area

Open the operating panel and the top cover of the machine

On the left-hand side in the machine, you will find a blue lever. Pull this lever forwards and pull out the paper upwards.

Close the machine.

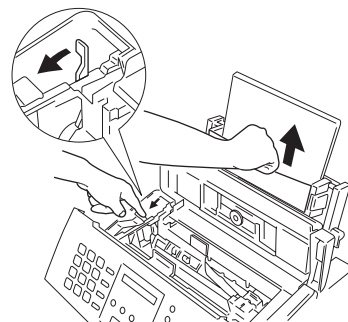

Remove paper jam before document tray

Open the operating panel and the top cover of the machine

On the left-hand side in the machine, you will find a blue lever. Pull this lever forwards, and pull the paper out of the front of the machine.

Close the machine.

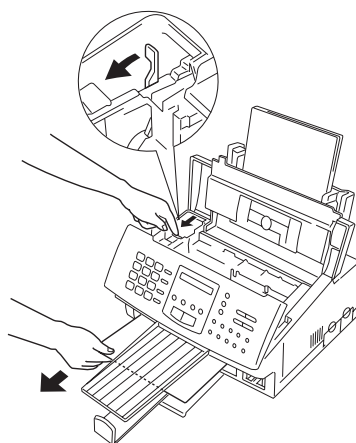

Document jam

Open the operating panel.
Pull out the paper upwards

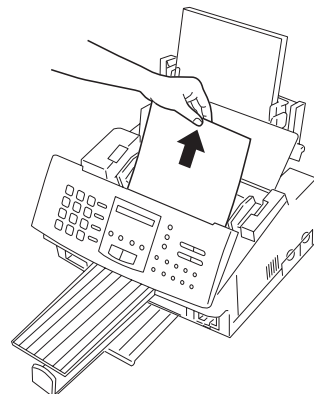

Your TF 461 as a printer

System requirements

Connect your TF 461 to a computer which meets the following system requirements:

CPU:

- i80386SX (or higher)

RAM:

- min. 4 MB

Hard disk space:

- min. 5 MB free space

Software:

- **MS-DOS version 5.0** or higher;
- **Microsoft Windows** version 3.0/3.1 or higher (in extended -386 enhanced-mode)
- **Microsoft Windows 95**
- IBM OS/2 1.3/2.0 or higher

If you would like additional information for installing the printer drivers, you can read or print out the README.TXT file. After the printer driver has been installed, this file can be found in the directory \PRTCIJP.

Connecting the fax machine to the computer

The TF 461 has an 8-bit Centronics parallel interface. Perform the following steps to connect the TF 461 to your computer:

1. Disconnect the TF 461 from the main supply.

2. Switch your computer off.

3. Connect a parallel cable to the corresponding socket on the rear of the TF461.



Parallel printer cable not supplied.

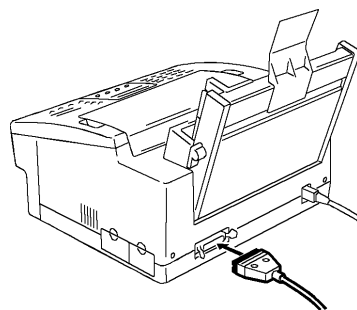

4. Secure the connector on the parallel cable by means of the wire clips.

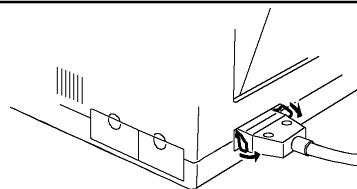

5. Connect the other end of the parallel cable to a spare parallel port on your PC.



Parallel cables should be no longer than 2 meters.

Your TF 461 as a printer

Changing the ink cartridge

Your TF 461 can print monochrome as well as color documents. A monochrome ink cartridge is used for fax operation. You will have to replace the ink cartridge if the machine is also to be used as a color printer. The following diagram shows you how to change the ink cartridge. The replaced ink cartridge can easily be stored in the cartridge compartment.



The color ink cartridge can also be used for printing monochrome documents. However, if

large monochrome areas are to be printed, it is recommended that the color ink cartridge be replaced by a monochrome cartridge.

Press

CHANGE CARTRIDGE



CHECK CARTRIDG M100%



Ensure that the printhead has moved to the left into the changing position before replacing the ink cartridge. You will damage the machine if you try to replace the cartridge in another position!



Press the following again if the printhead is not in this position.



CHANGE CARTRIDGE

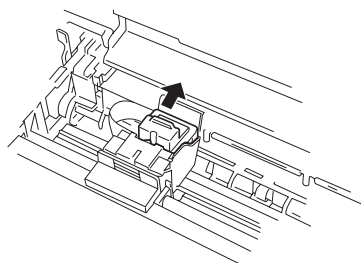
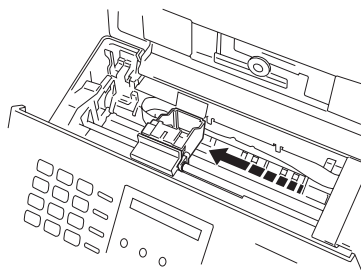

Loading the paper

Your TF 461 offers various options of loading the printer paper

- Automatic sheet feed (max. 150 sheets)
- Automatic envelope feed
- Manual single sheet feed

Paper formats

The following paper formats can be used as printer paper in your TF 461:

	Automatic feed	Manual feed
Length	127 - 364 mm	127 - 364 mm
Width	89 - 216 mm	76 - 228 mm
Weight	60 - 90 g	60 - 129 g
Thickness	0,071 - 0,191 mm	0,071 - 0,191 mm

Your TF 461 as a printer

The automatic sheet feed

The best print results are achieved with high quality paper. However, special recycled paper is now also suitable for ink jet printing. It is also possible for film to be loaded into the sheet feeder. Max. 150 sheets can be inserted in the sheet feeder, depending on the thickness of the paper which is used. Please ensure that only one type of paper is inserted in the sheet feed.

1. Using your thumb and index finger, press the paper release lever of the left paper guide and move it to the left stop.



The right paper guide cannot be changed.

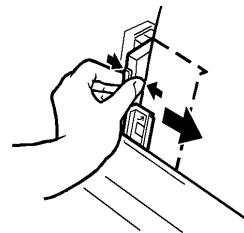

2. Push back the paper release lever and insert the stack of paper. Do not exceed the maximum capacity of the sheet feed.

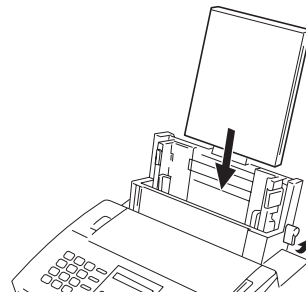

3. Move the left paper guide to the left edge of the sheet so that the paper rests flush against the guide.

4. To set the paper release lever to its working position, pull the lever towards you.

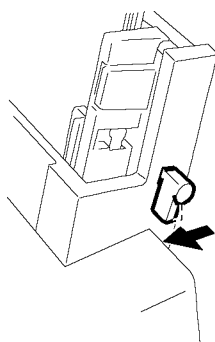
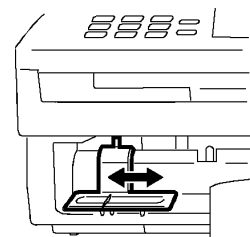

The automatic envelope feed

You can also load envelopes in the automatic sheet feed. Do not use more than 15 envelopes.

1. Turn the two envelope guides towards the rear of the machine until they snap into position.

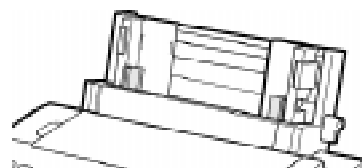

2. Using your thumb and index finger, press the paper release lever of the left paper guide and move it to the left stop.



The right paper guide cannot be changed.

3. Push back the paper release lever and insert the stack of paper. Do not exceed the maximum capacity of the sheet feed.

4. Move the left paper guide to the left edge of the sheet so that the envelopes rest flush against the guide.

5. To set the paper release lever to its working position, pull the lever towards you.

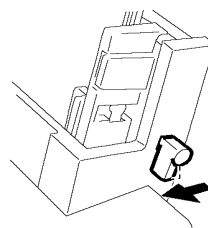
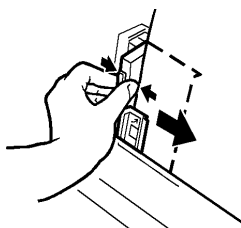
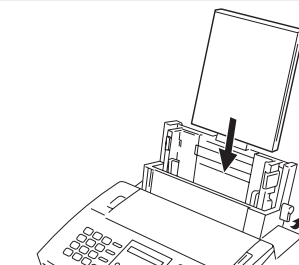

Your TF 461 as a printer

The manual single sheet guide

The manual feed enables you to print separate sheets irrespective of what is already in the printer.



The printer always prints on the side facing you.

1. Insert the paper as detailed by the symbol on the single-sheet feed.
 - Always ensure that sheets of paper are flush against the right edge of the sheet feed.
 - Always ensure that envelopes are flush against the marked envelope edge of the sheet feed.
2. Press the "VORSCHUB" button until the sheet is drawn into the machine.
3. Start to print

Insert only **one** sheet in the manual sheet feed

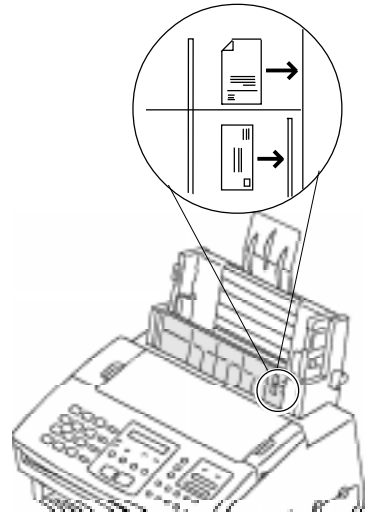

Installing the printer driver software

Every program which controls a printer requires a printer driver. This is a special program which converts the print data into the correct form which can be understood by your printer. Printer drivers are provided for the following programs:

- Harvard Graphics 3.0
- Lotus 1-2-3
- Microsoft Windows 3.X
- Microsoft Windows 95
- IBM OS/2
- Microsoft Works 2.0, 3.0
- Microsoft Word 5.5, 6.0
- Wordperfect 5.1, 6.0 for DOS

The installation program helps you to perform the correct steps.

Switch the computer and the fax machine on.

The following installation procedure should be performed at the DOS level.

If your computer automatically loads Windows, please exit Windows and enter the DOS level.

For this purpose, open the menu **File** in the program manager and then click on **Exit Windows**.

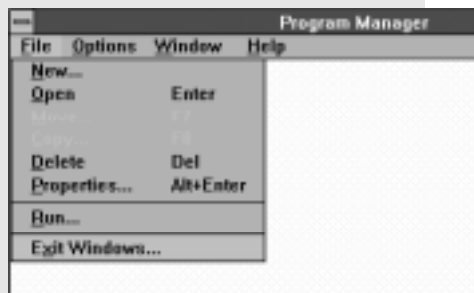

Your TF 461 as a printer

Then click on **OK**

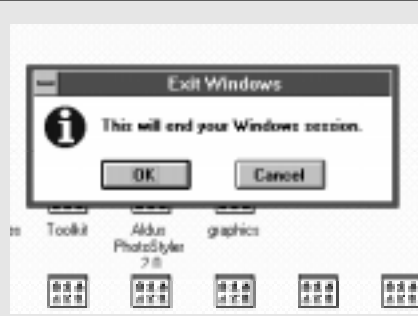

To install from the DOS level

- Now insert the SETUP DISK in the floppy disk drive of your computer.
- Enter the letter of the drive in which the disk has now been inserted (e.g. drive A).

The DOS prompt is now displayed on the screen:

a: ↵

A:\>_

setup ↵

- Enter **SETUP**:

The installation program is started:

If you require further information, you can obtain an additional HELP text at any time by pressing the F1 key; this will assist you in any situation. The green fields are buttons; use the mouse to click on these buttons. If you do not have a mouse, you can also activate these buttons by means of a combination of the ALT key and the letter which is highlighted in yellow.

- Click on **OK** or, if you do not have a mouse, press ALT-O.

Information

Printer Setup Utility

Welcome to the Printer Setup Utility.

This utility will:

- check that your printer is properly connected to your computer
- install printer drivers
- install the Printer Toolkit
- complete the setup of your printer's options

Choose **OK** to continue. Choose **TUTORIAL** to begin with some instructions on how to use this utility.

To choose a button if you don't have a mouse, press and hold the Alt key while you type the highlighted letter (O or T).

OK

TUTORIAL

F1 Help

AltF4 Exit

F10 Menu Bar

Your TF 461 as a printer

- Accept the current setting (parallel cable) and click on **OK**.

Your are now able to check whether your TF 461 has been correctly connected by means of a test printout. If you do not require a test printout, select "**Skip**".



A sample document can only be printed with a color cartridge! Select "**Skip**" if a color cartridge has not been installed.

The system starts to copy the printer driver

- To select Express, use the mouse to fill the field ().
- Then click on **OK**.

Information

Default Printer Port Selection

Select the PC output port where your printer is connected.

This utility will use the selected port to communicate with your printer, as well as to update your applications when drivers are installed.

Choose **OK** to continue after selection, or choose **RETURN** to return to the previous screen.

Port
Parallel Cable (LPT1)
Serial Cable (COM1)
Serial Cable (COM2)

OK

RETURN

F1 Help

AltF4 Exit

F10 Menu Bar

Information

Printing a Sample Document

Let's see if your printer is properly connected to your computer.

First, be sure your printer is turned on.

Then, choose **OK** and a sample document will be sent to your printer.

Default Port: LPT1

OK

SKIP

F1 Help

AltF4 Exit

F10 Menu Bar

Information

Choosing Setup Method

You are now ready to choose between two methods of setup: Express and Custom. 'Express' is the quickest and easiest method. 'Custom' offers more flexibility if you have special requirements. If you want to choose how your system is set up, you should select the 'Custom' method.

Choose a setup method from the menu below.

If you need help deciding which method to choose, press F1.

Methods
(") Express
() Custom

OK

RETURN

F1 Help

AltF4 Exit

F10 Menu Bar

Your TF 461 as a printer

At this point, the setup program checks all installed hard disks for programs for which you require the printer.

- Click on **OK**

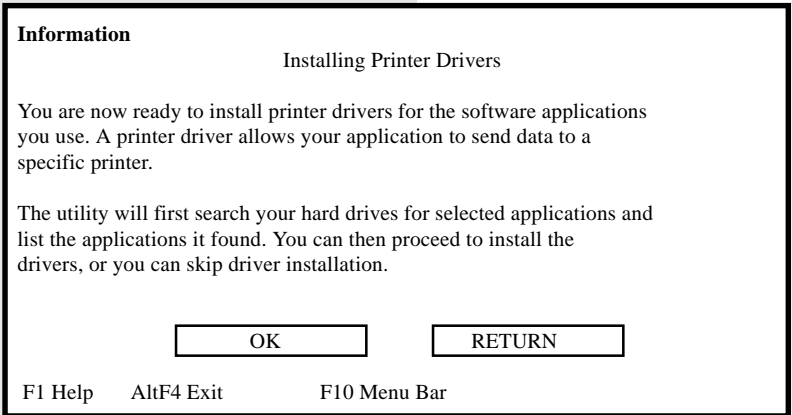

The system displays a list of the programs which the system is looking for on your hard disk or hard disks. Depending on the size of the hard disk(s), this search can take quite some time.

- Click on **OK**

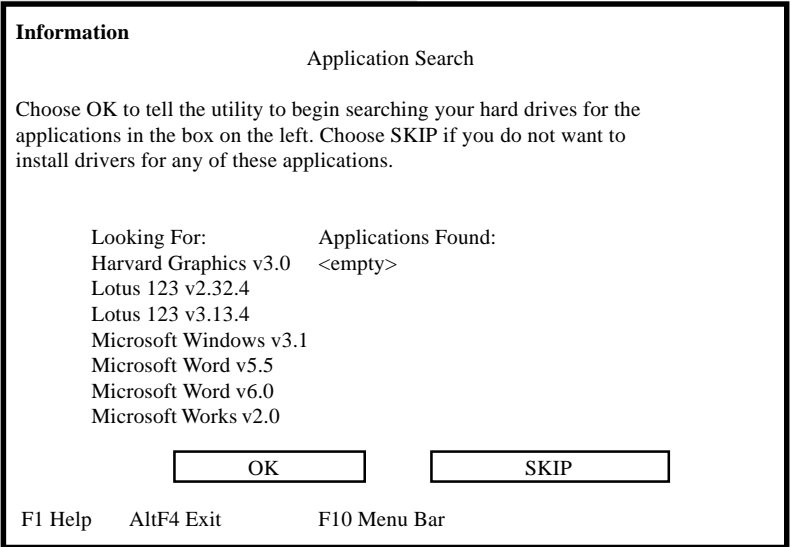

At this point, you can see the result of the search. In this example, the system has found Microsoft Windows as the application.

- Click on **OK** to confirm the result.

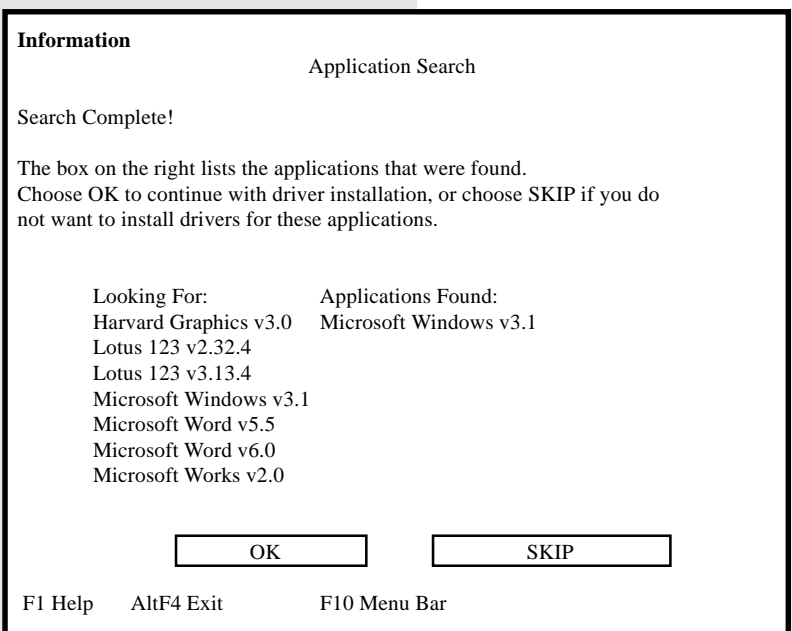

Your TF 461 as a printer

When you install Toolkit (see [page 78](#)), you obtain useful applications with which you can set and check your printer. You can specify the directory at this point. However, we recommend that you use the default path.

- Click on **OK**

If you would also like to use the Toolkit under Windows, you will have to insert a program group and an icon. This section of the setup procedure performs this task for you.

- Click on **OK**

The setup procedure is complete.

- Click on **OK**

All drivers identified by the search result and your specifications have now been loaded and activated. From now onwards, you can operate your TF 461 as a printer.

Information

Install Printer Toolkit

The Printer Toolkit is a set of useful PC utilities customized for your Color Inkjet Printer. Choose Help for a description of the tools.

Once installation is complete, DOS users can type TOOLKIT from the prompt to start the Printer Toolkit. Windows users can start the Printer Toolkit from the Printer Toolkit icon.

Please confirm the path location where you want the Printer Toolkit installed and choose OK, or choose SKIP to skip installation of the Printer Toolkit.

Path Location for the Printer Toolkit
C:\PRTCIIJ

OK

SKIP

F1 Help

AltF4 Exit

F10 Menu Bar

Information

Microsoft Windows Location

If you have Windows and would like an icon added to the Windows desktop to start the Printer Toolkit, choose OK.

If Windows is not stored at the location shown below, type the correct path and choose OK.

Choose CANCEL if you don't want to add a Windows icon for the Toolkit.

Windows path:
C:\WINDOWS\

OK

CANCEL

F1 Help

AltF4 Exit

F10 Menu Bar

Information

Printer Setup Complete

Printer Setup is complete!

Don't forget, if you installed the Toolkit on your hard drive, you can use it any time you need it! It offers you a variety of tools you might find handy for your printer.

To use the Toolkit:

Choose EXIT to end the Printer Setup Utility.

Reboot your computer to activate changes in your system files.

Type TOOLKIT at the DOS prompt.

EXIT

F1 Help

AltF4 Exit

F10 Menu Bar

Your TF 461 as a printer

Printer setup (colour printer)

You can adapt the function of the selected printer (here: colour ink jet printer on LPT1) to suit your specific requirements. Open the window **Printers**, as detailed in the section **"Setting the Default Printer"** (page 81).

Click on the button **Setup...**, in order to open the printer setup dialog.

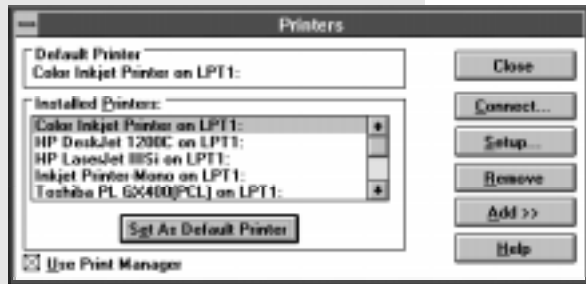

The printer facilities consist of six pages:

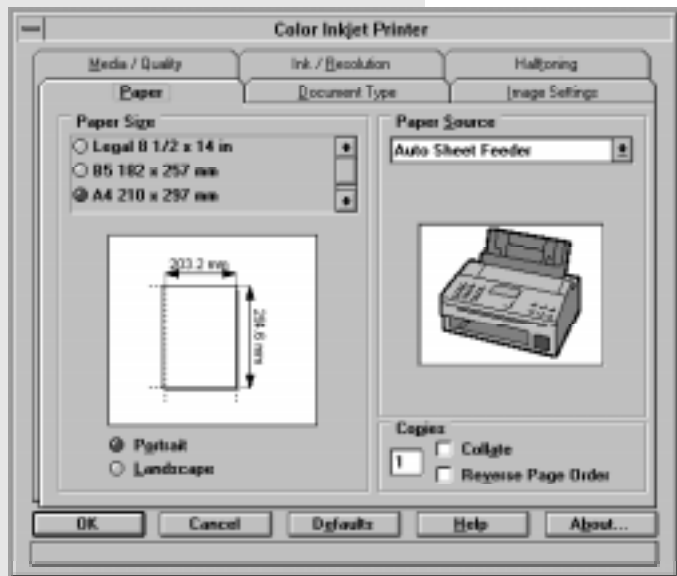

These pages contain setting options assigned to the various overall terms. They are activated by clicking on the corresponding "flap" with the mouse.

The various pages are described in the following:

General:

The buttons at the bottom of the screen are identical for all files.

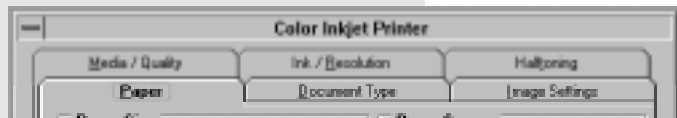

Meaning of buttons:

- OK: Confirm the settings of the particular file.
- Cancel: The settings are not changed.
- Defaults: Default values (factory settings) are activated for the particular page.
- Help: Extensive help menu for the corresponding file is opened.
- About..: This details information concerning copyright and version.

In addition, you can consult a context-sensitive help facility by pressing the F1 key in any menu level.

Your TF 461 as a printer

Paper

Paper size

This sets the print area depending on the type of inserted paper.

Paper source

Describes the paper feed source.

Copies

Number of copies. Multiple copies are sorted. If reverse sequence is used, the final page is printed first.

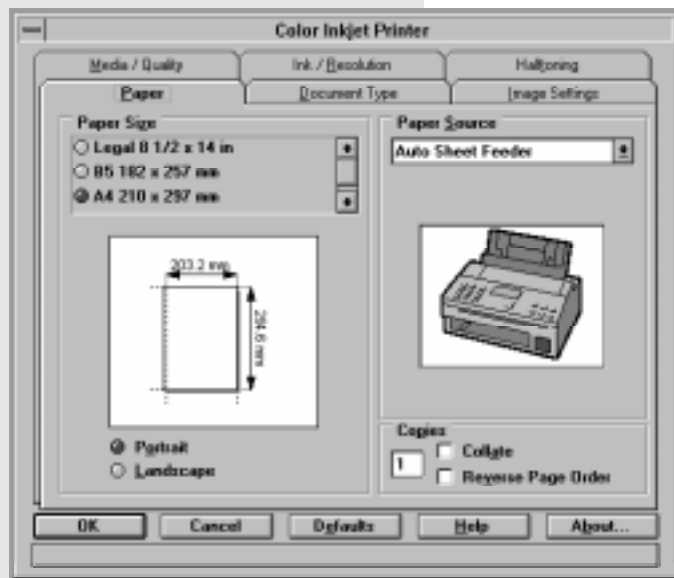

Media / quality

Media type

Select the print medium at this point. Depending on the choice which you make at this point, the system changes the setting for the print quality so that the print quality on special print media is the same as that achieved on paper (e.g. transparent film, coated or glossy paper).

Print quality

This option enables you to define the quality of the printout. The setting may also affect the speed of the printing process.

Ink saver

This setting controls the quantity of ink used on the paper during the printing process. With ink saver selected, the machine "omits" some dots. You can save ink with this facility and improve the quality of printing on recycled paper.

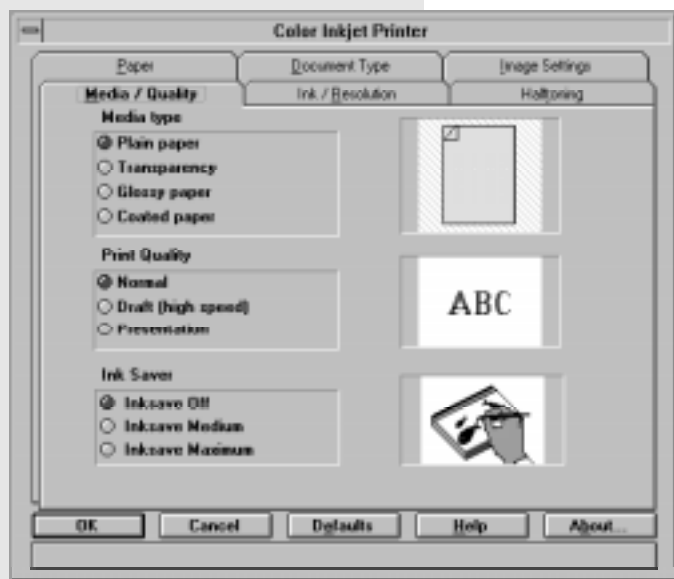

Your TF 461 as a printer

Document type

Document types

The document type option is used to set up the driver quickly for a particular type of document. Once a document has been selected, other options within driver setup are adjusted accordingly.

For instance: If desktop publishing is selected as the document type, maximum resolution and best print quality are selected, and all other options are retained. You can also change the settings affected by the document type setting yourself; if you do this however, the choice of document type will be cancelled.



If you only want to print text from a word processing program, select "Text" at this point. Please note that the monochrome ink cartridge is necessary for this purpose.



Ink / resolution

Colour format

Select the colour mode at this point. You must subsequently insert the correct ink cartridge depending on your particular decision.

PQET

If you have set **monochrome** under colour format, you can also activate edge enhancement at this point. The PQET facility (Print Quality Enhancement Technology) improves the print quality. A resolution of 300 x 600DPI is then used for printing. In this way, the edges of letters and most graphics are enhanced, and the printout is more sharply focussed.

Resolution

You can change the print resolution at this point.

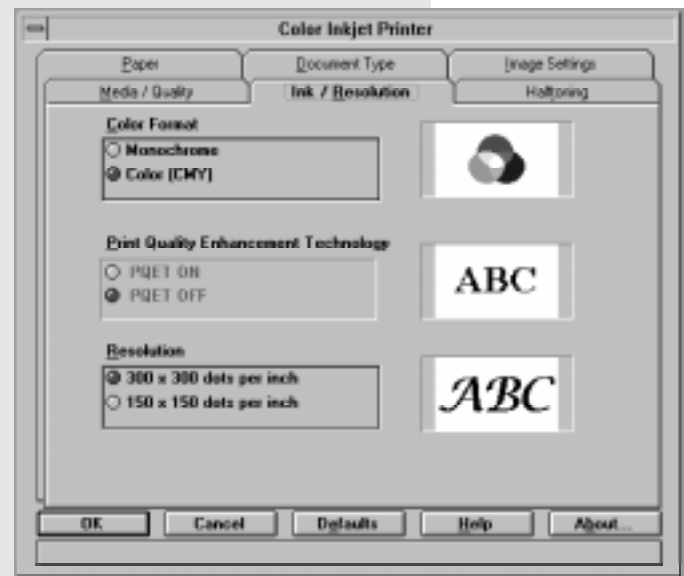

Your TF 461 as a printer

Image settings

Image

Consider these settings in the same way as the settings for your colour television. The **"Enable ink density correction"** facility enables the printer result to be adapted to the screen display.

Colour

Use this facility to influence the individual colour components. If the components are not equal, the printout is given a corresponding colour cast.

You can simultaneously assess the results of the manipulations on the adjacent colour diagram.



If you have inserted the wrong ink cartridge, the message "CHECK CARTRIDG M100%" appears in the display of the TF 461.

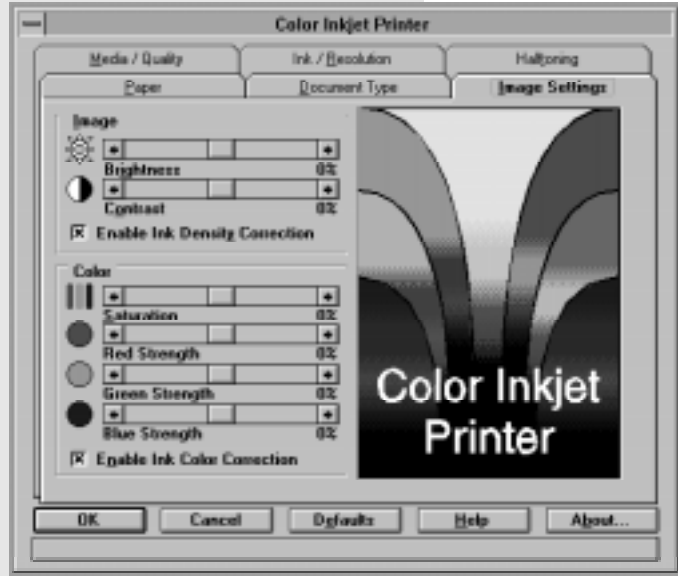

Halftones

Halftone

You can use this feature to influence the type of dither pattern when halftone printing. The dither pattern method usually provides structured images, and is suitable for word processing and printing out simple graphics. The halftone option can be deactivated for printing out simple non-dithered text. Use the air brush option if you wish to improve the reproduction of photographs and if you want to achieve softer images. This method also produces excellent output quality for text. Select the halftone option which is suitable for the image to be printed.



Test various halftone options in order to establish which option is most suitable for your printing needs.

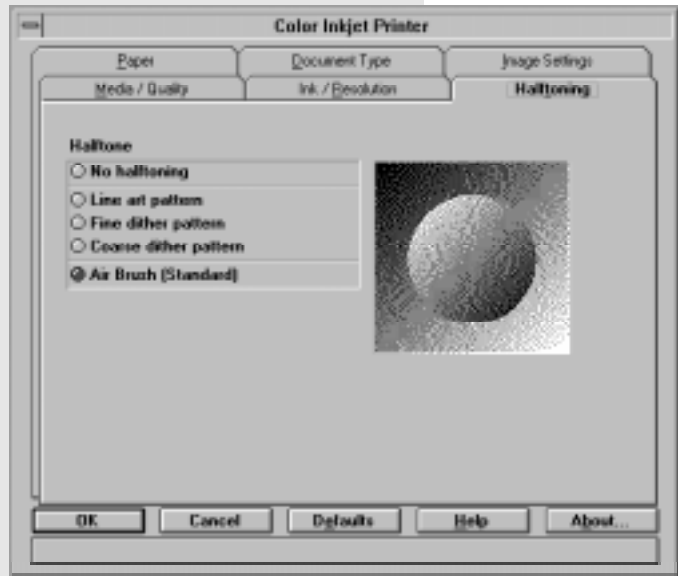

Your TF 461 as a printer

Printer setup (monochrome)



This printer driver is the best option if you only want to print in monochrome. In this way, you do not have to make any unnecessary settings for colour printing.

You are able to adjust the function of the selected printer (ink jet printer - mono on LPT1) to suit your own specific requirements. Open the window **Printers**, as described in the section **"Setting the Default Printer"** (page 81).

Click on the button **Setup...** in order to open the printer setup dialog field.

The following setting options are displayed:

Paper size

This sets the print area depending on the type of inserted paper.

Paper source

Describes the corresponding paper feed source

Graphics resolution

You can influence the print resolution at this point.

Orientation

Set landscape or portrait format at this point.

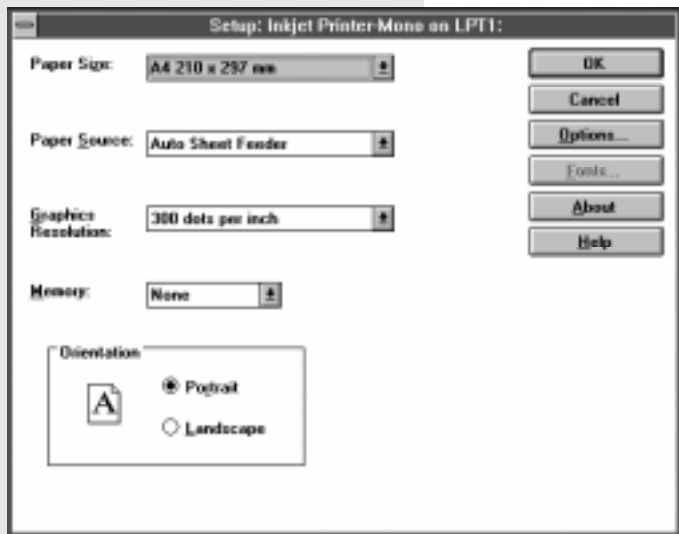
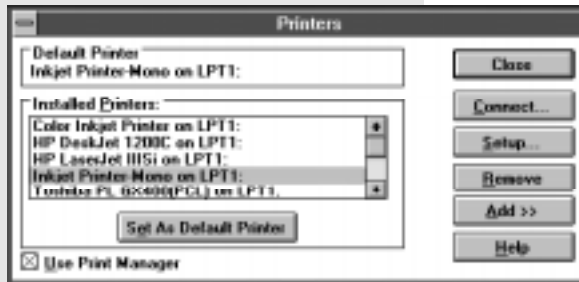

Your TF 461 as a printer

Click on **Options ...** to make further settings.

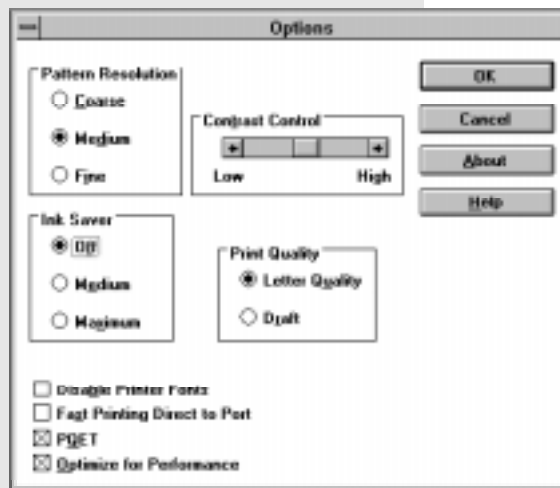

The following additional setting options are displayed:

Pattern resolution

The setting of the dither pattern has an effect on the way in which details in graphic illustrations are displayed. The combination of the settings for the graphics resolution, the sample resolution and the contrast control influences the general appearance of the graphics.

Contrast control

The contrast control settings specify how much difference there is between the various grey stages. The combination of the settings for the graphics resolution, the pattern resolution and the contrast control influences the general appearance of the graphics.

Ink saver

The ink saver mode reduces the amount of ink used for printing in letter quality (not draft quality); this facility ensures that certain dots are not printed.

Print quality

This setting defines the printout quality. Maximum density is used for printing letter quality, and the density is reduced for draft quality. This facility produces a weaker image but increases the printing speed.

Fast printing ...

This option uses the protocol of the parallel interface which enables data to be sent to the printer more quickly. This option should be marked in order to optimise performance.

PQET

The PQET method (Print Quality Enhancement Technology) improves the print quality. If you activate PQET, the edges of letters and most graphics are enhanced, and the print is more sharply focussed.

Optimise for performance ...

If you select "**Optimise for performance**", the printer driver is configured in such a way that the amount of system time used for the printer driver application is restricted to a minimum. The print performance is increased in most cases. However, in some applications the "**Optimise for performance**" option can result in missing text and/or graphics or incorrect overlay of text and/or graphics.

Your TF 461 as a printer

The printer status display

Each printout contains the status display of the printer driver:



This provides you with an online check of the current printer status.

The following information is provided:

- File name
- Time printing
- Processed area
- Page number

You can influence the current print job with the buttons:

Delete the current job.



Stop the current job.



Display the following menu:



The buttons have the following meaning:

Page

The page which is currently being printed is rejected, and the printing process resumes at the start of this page.

Document

The document which is currently being printed is rejected, and printing of this document starts again from the beginning.

Queue

The document which is currently being printed is rejected and queued; it is then printed at a later time.



Your TF 461 as a printer

The printer status display also notifies you of any problems in the printer:

The following problems are displayed:

- Wrong ink cartridge
- Empty ink cartridge
- Paper jam
- Paper out
- Transmission cable defective
- Printer not ready

The status display then changes as follows:



The spool manager

Once you have printed for the first time, the icon of the spool manager is displayed in the bottom left corner of Windows. The spool manager controls the handling of incoming print jobs: it sorts the various print files and monitors the process of sending the files to the printer.

Double click on the icon to open the spool manager.

You can see the function of the spool manager in this example. Two print jobs are present, and the first job (Druck461.DOC) is currently being processed. The resulting queue of print jobs can be edited quite easily:

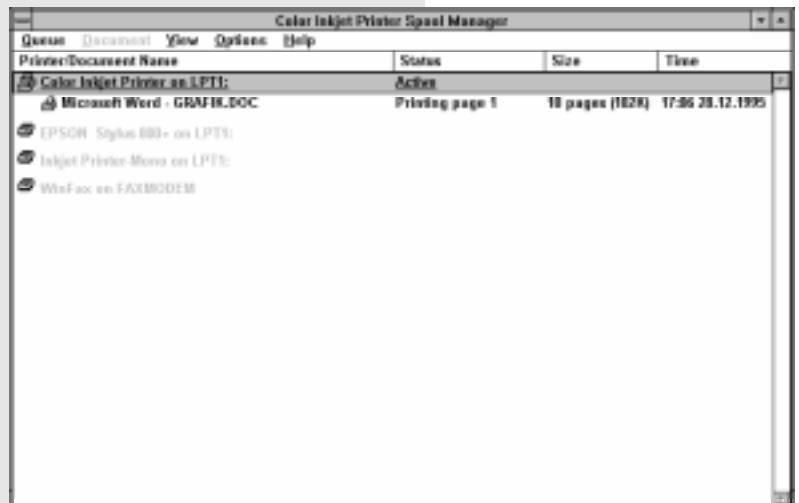

Your TF 461 as a printer

Double click on a print job of your choice:

The system opens a small menu where you can influence the selected print job.

OK

Confirm the settings which have been made

Cancel

The situation is not changed

Delete

Deletes the print job from the stack

Requeue

The corresponding print job is requeued and printed out at a later time.

Hold job

If a job is currently being printed, it is immediately stopped; if a print job has been placed in the queue, it is not carried out.

Keep job after printing ...

When this job has been printed out, the system creates a file in which the print job is stored on the hard disk.

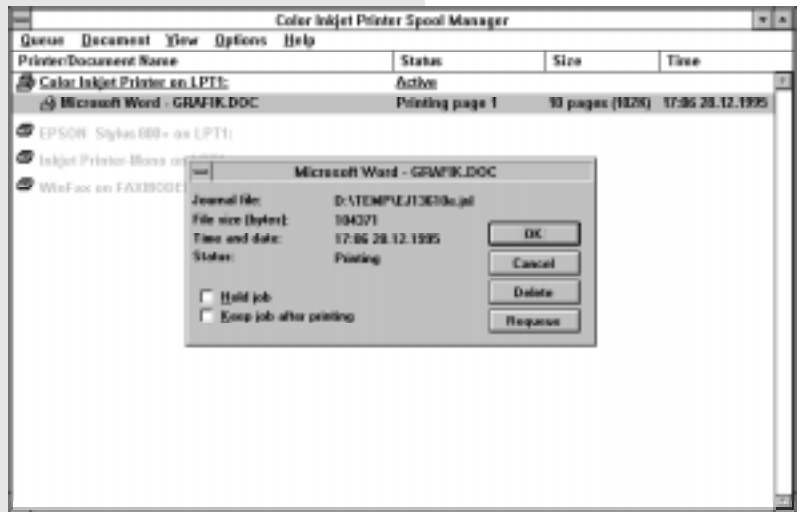

Your TF 461 as a printer

The Toolkit



The Toolkit is generally required when you want to adapt the driver to specific DOS programs!

The printer Toolkit is a program which you can use to adapt the printer and your computer to meet your specific requirements.

The previous setup procedure has installed the Toolkit on the hard disk of your computer.

To select the Toolkit

- under DOS

Change to the current directory where the Toolkit is located:

(If you have selected a different directory during the setup procedure, please select the corresponding directory).

(If you have selected a different directory during the setup procedure, please select the corresponding directory).

The DOS prompt now appears on the screen:

```
cd \prtcijp ↵
```

```
C:\PRTCJJP>_
```

```
TOOLKIT ↵
```

Enter **Toolkit**:

- under Windows

1. Open the program group Toolkits by double-clicking on the icon.

2. Open the printer utility program by double-clicking on the icon.

3. Click on Toolkit in order to start the program.



Toolkit



Your TF 461 as a printer

The Toolkit program is started:

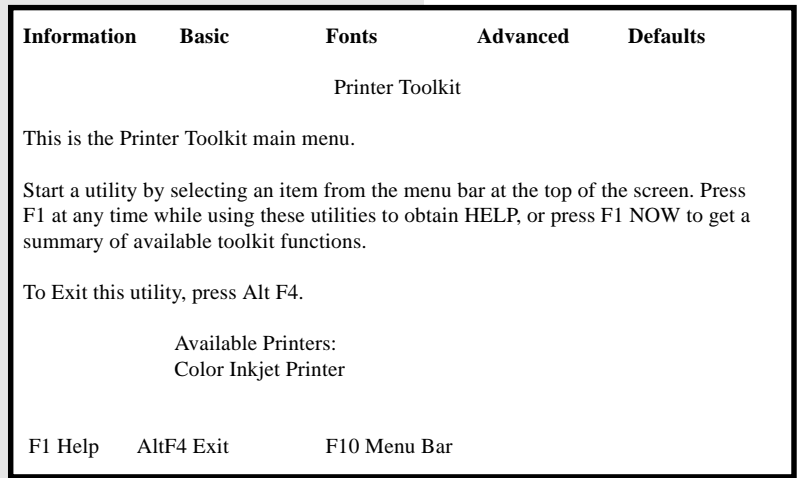

The individual program points can be selected by means of pulldown menus. For this purpose, click on the corresponding terms in the top line, or simultaneously press the ALT key and the corresponding red letter. The example illustrates the **information menu** (window):

Once you have opened the menu, you can click on the desired menu item, or go to the menu item using the cursor keys and then press Return. You can again obtain a special help text via the F1 key in every level.

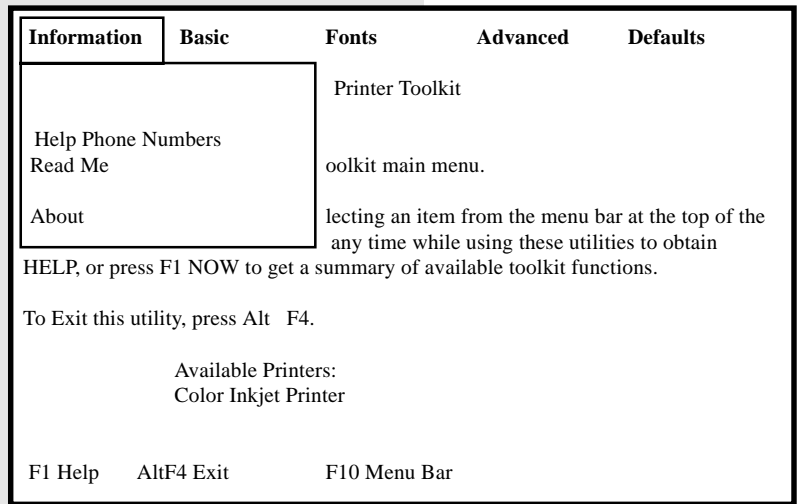

Your TF 461 as a printer

The individual menus are described in the following:

Information

Read Me

This contains the latest information concerning the Toolkit which you are just using. Technical changes which were too late to be included in this manual are also contained in this information. We recommend that you print out this part, and you will find the appropriate menu item at that point.

About

Here you will find the version number of this software.

Basic

Update Application Printer Driver

If new applications have been added after your printer driver has been installed, you can use this item to update the printer driver.

Print Sample Document

Here you can print out the technical data of your printer in the form of a sample printer (color or monochrome)

Advanced

Install Toolkit

If you are using the Toolkit program from a floppy disk, you are able to copy Toolkit to your hard disk.

Send Printer Commands

Your printer reacts to special print commands which the printer driver normally provides. You are able to "manually" send these commands to your printer.

Download Demos

If you have any print files, this item enables you to print them out via the printer.

The following details relate only to Windows applications and it is thus assumed that the Windows user interface has been installed.

Your TF 461 as a printer

Setting the standard printer

When the printer driver has been installed, you are able to select two different types.

- Color ink jet printer (color printer)
- Ink jet printer mono (monochrome printer)

The corresponding printer driver may be useful depending on a specific application. Please also ensure that the ink cartridges have been installed correctly (see [page 6, 7](#)).

Please perform the following steps in order to select the standard printer:

In the program manager window, double click on the **Main** icon.

Double click on the **Control Panel** icon in the Main window.

Double click on the **Printer** icon in the Control Panel window. The printer selection window is opened:

The easiest way to define the standard printer is to double click on the name of the driver in the field **Installed Printers**. Then click on the button **Close**.

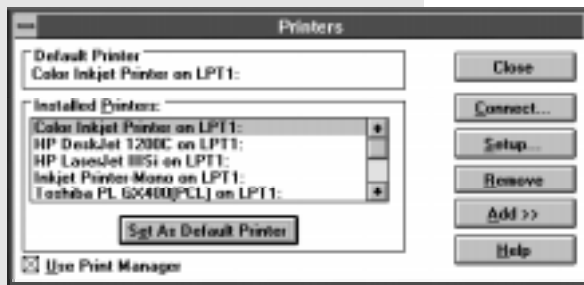

Configuration of the printer

Draft/ LQ printing

A high print quality is not always necessary. For instance, if you want to make a test printout which is also quite large, then draft printing is an alternative. Fewer ink jets are used during the draft printing mode; this reduces the print quality and increases the print speed. In addition, ink consumption is reduced in this mode.

 The setting is only effective if you use the PRN command at the DOS level. If you are printing via the installed printer driver, e.g. under Windows, the print quality is controlled by the settings of the printer driver.



Press the DRAFT/LQ button

Draft printing is activated

Press the DRAFT/LQ button

Letter printing (factory setting) is activated

Paper orientation

You are able to choose between printing using the portrait format or using the landscape format. The portrait format is generally used for normal letters, and landscape format can be used for tables.

 The setting is only effective if you use the PRN command at the DOS-level. If you are printing via the installed printer driver, e.g. under Windows, the orientation is controlled by the settings of the printer driver.

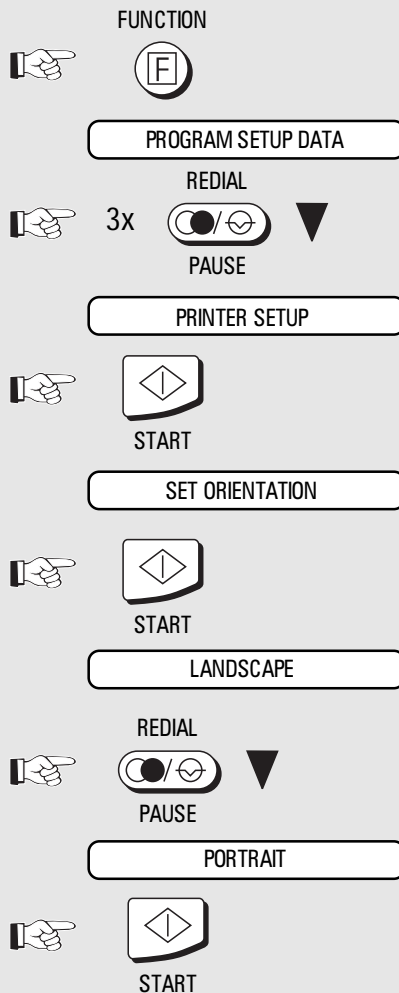

To start the menu

Page through the menu...

...until you reach the desired menu item

Confirm with START

Confirm with START

Display the current orientation

Select the desired menu item

Confirm with START

Configuration of the printer

Adjust alignment

In the bi-directional print mode (see page 49 for setting the function {function 68}), the printhead operates in both directions. It is particularly difficult for the printhead to print vertical lines in this mode. If vertical lines are therefore not completely straight, you can adjust the alignment of the printhead as follows:

Scheme:

Right correction necessary:

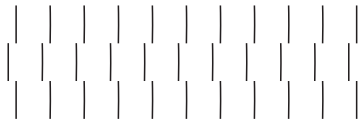

Left correction necessary:

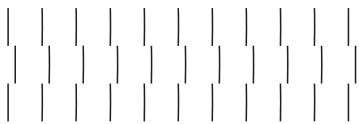

Optimum alignment:

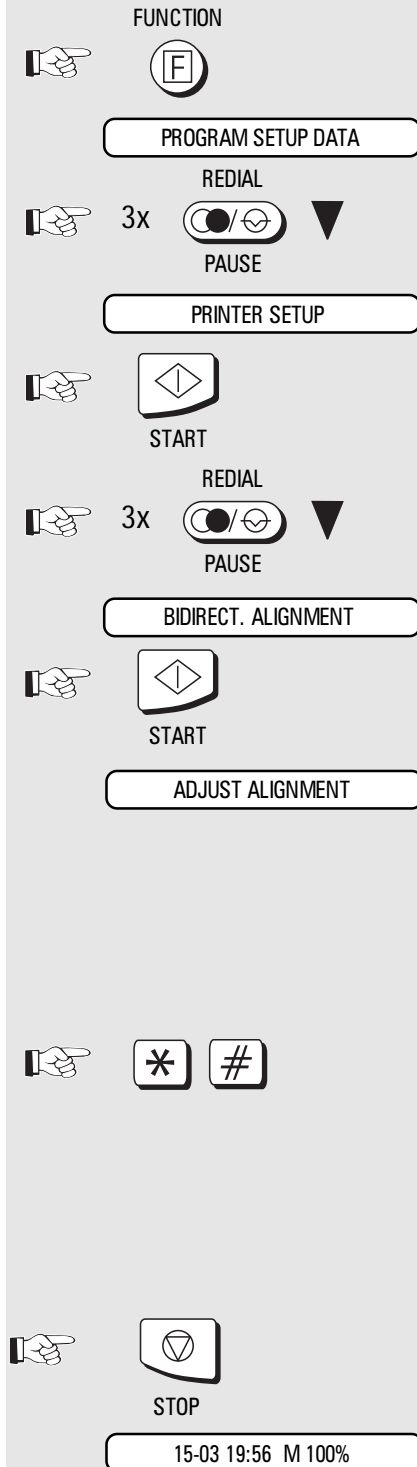
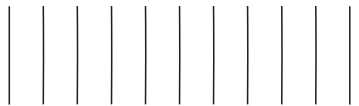

Open the TF 461 as if you wanted to replace the printer cartridge. Ensure that the inside of the machine is well lit (use a torch).

To start the menu

Page through the menu...

...until you reach the desired menu item

Confirm with START

Page through the menu...

...until you reach the desired menu item

Confirm with START

Please wait until the page has been drawn into the machine and the initial printing process has been completed (this will take some time)...

Now look at the section which has just been printed in your TF 461. A number of vertical lines has been printed. If you can see that the lines are not perfectly straight, you can adjust the machine using the following buttons:

* - Button = Left correction
- Button = Right correction

A test printout is made after every adjustment. Check the new result, and repeat the correction if necessary.

When the printed lines are perfectly straight:

Press STOP to return to the standby mode

Configuration of the printer

Cleaning the printhead

If the quality of the printout deteriorates, you can clean the printhead. An internal cleaning procedure is then used for the jets.

 Please use this function sparingly as relatively large quantities of ink are consumed.

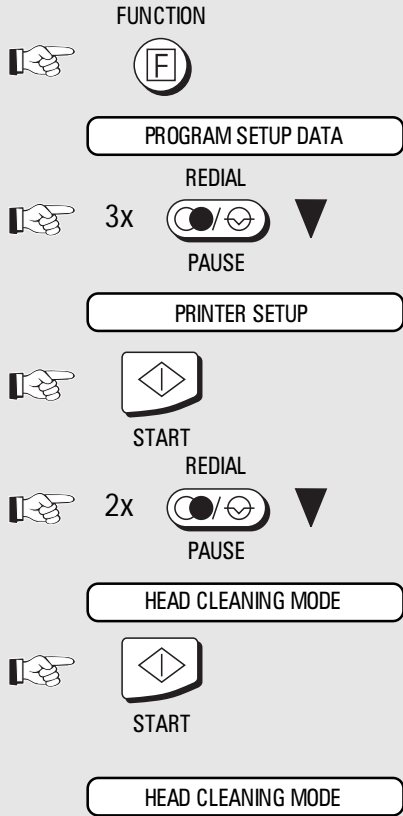

To start the menu

Page through the menu...

...until you reach the desired menu item

Confirm with START

Page through the menu...

...until you reach the desired menu item

Confirm with START

Please wait until the page has been drawn into the machine and the test printout has been completed.

Test printout

The test printout illustrates the fonts in the printer on a single page. The grey bar also indicates whether individual jets are defective.

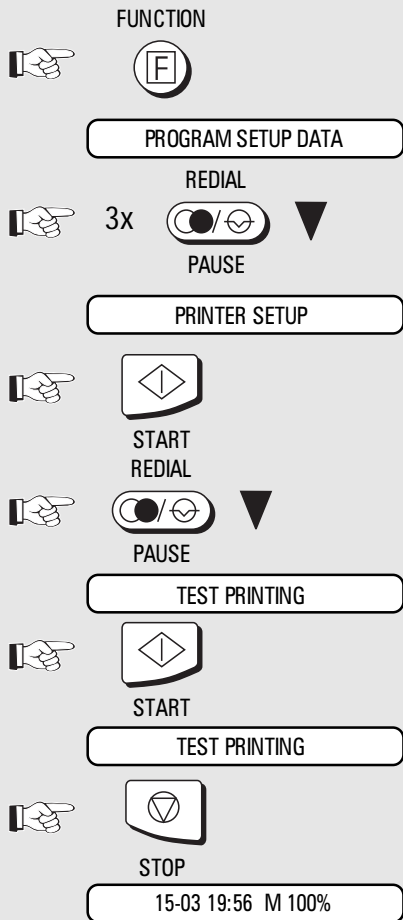

To start the menu

Page through the menu...

...until you reach the desired menu item

Confirm with START

Page through the menu...

...until you reach the desired menu item

Confirm with START

Please wait until the page has been drawn into the machine and the test printout has been completed. The test printout continues until you...

press STOP to return to the standby mode

Configuration of the printer

Hex dump mode

This function is only meaningful if you wish to adapt a DOS driver. The data which are sent to the printer are normally interpreted as equivalent characters by the printer. If you wish to identify the specific data which are being sent to your printer, you can switch over the mode of the printer. The data are now no longer interpreted, and are printed instead in the form of hexadecimal characters.

 The Hex dump mode is deactivated as soon as a list is printed, a copy is made or a fax message is received.

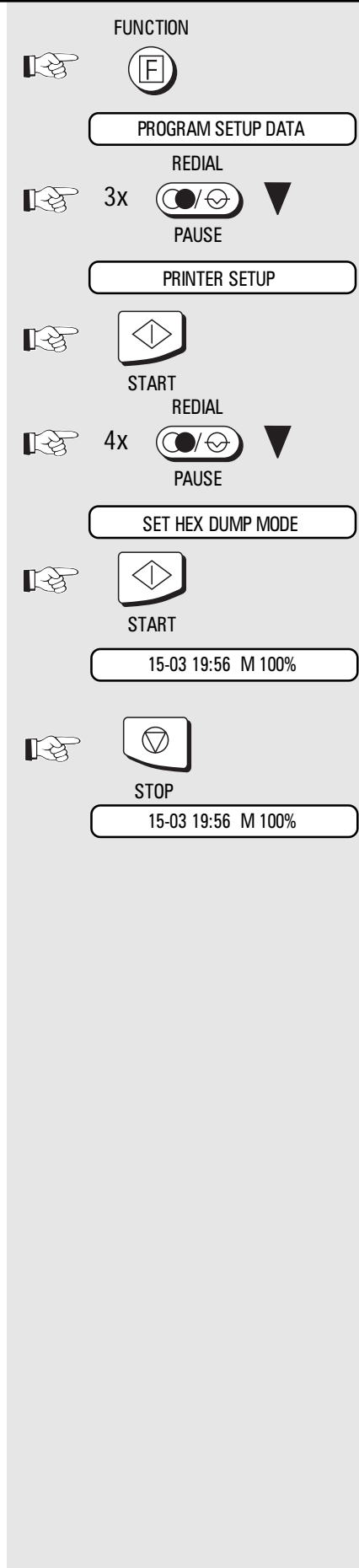

To start the menu

Page through the menu...

...until you reach the desired menu item

Confirm with START

Page through the menu...

...until you reach the desired menu item

Confirm with START

Ready
The printer remains in the Hex dump mode until you...

press STOP to return to the standby mode

Handling faxes on your PC

System requirements

You can also use the features of your fax machine your PC. The fax functions can also be used in addition to the printer function. The following minimum requirements are essential in this respect:

- IBM compatible PC with i80486 processor or higher
- 4 MB RAM or higher
- Serial (V.24) interface for connection to the TF 461
- MS-DOS 5.0 operating system or higher
- Class 1 fax software (e.g. WinFax Pro 4.0)
- Serial interface with 16550 UART module*)

*) The UART-module controls the data transfer process of the serial interface. At transmission speeds of more than 9600 bit/s, the UART 8250 module and compatible modules frequently used in a PC do not always operate perfectly. As your fax machine transports data via its serial interface at approx. 19200 bit/s, there may be problems with the UART 8250. If data transmission from your fax machine to the PC (and vice versa) does not function perfectly, it maybe necessary to replace the existing UART module with a UART 16550 (manufacturer: National Semiconductor) or compatible module. In most PCs, the serial interface is implemented in the form of a plug-in card. In this case, replace the existing plug-in card with a new card featuring a UART 16550 module.

Features

With this system, you are able to operate your TF 461 as a **Class 1 faxmodem**. The following modes can then be used:



Please ensure that, when the fax software is installed (e.g. WinFax PRO), the modem type is set to Generic CLASS 1 (Hardware Flow Control).

The following features of WinfaxPro 4.0 are not supported:

- Polling
- Secure transmission/reception
- Broadcast
- File transmission
- Modem functions
- Network operation

Mode	Description
PC-Scanner	Reads documents into the PC from the sheet feed of the TF 461. A document is stored as an image file in the PC with a resolution of 200x200 dpi.
Send PC-Fax	Files which are created in the PC (e.g. from a word processing program) can be sent directly via the fax machine without having to be printed out.
Receive PC-Fax	Incoming faxes are transferred via the fax machine to the PC as an image file without being printed out. The pages are automatically printed out if the PC is not switched on.

Handling faxes on your PC

Connection to the PC

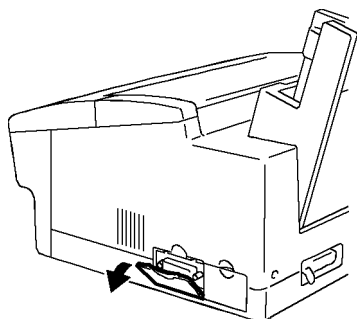

1. Switch off the PC and the TF 461.
2. Open the panel on the right-hand side of the fax machine.

3. Connect the 25-pin sub-D connector to the corresponding socket on the fax machine, and secure the connection with the connector screws.



This cable is not supplied.

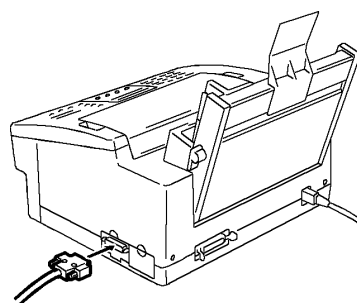

Pin assignment of serial cable

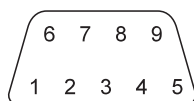

Sub-D 9 pin socket (female)

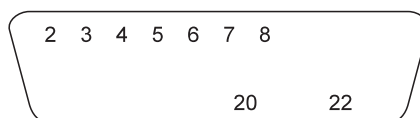

Sub-D 25 pin socket (male)

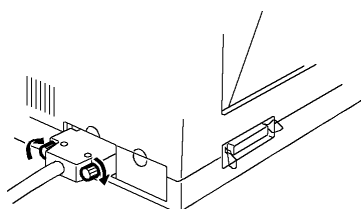
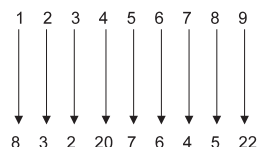

4. Connect the cable to the serial interface of your PC.



Install the software before connecting the TF461 to your PC. The PC does not need to scan the interface of the fax machine!

Handling faxes on your PC

Scanning documents into the PC

You can transfer your documents to your PC via the sheet feed of your TF 461. The document is then available as an image file in your PC, and can be processed as required.

*) This display indicates whether your PC is actually ready to receive.

The following conditions must be fulfilled:

- Ensure that the cable has been connected correctly
- The PC must be switched on
- The fax program must be loaded and active (e.g. WinFax PRO)
- The fax program must be set to automatic reception

Otherwise, the TF 461 will display the following after a certain amount of time:

PC COMM. ERROR #001

In this case, clear the error message by pressing the STOP button, and remedy the problem



Documents scanned in this way are stored in the form of image files in your PC. An OCR program must process this file if it is to be integrated within a word processing program. This process is essential if the file is to be used as a text file (contained in WinFax PRO).

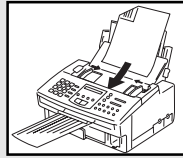

DOCUMENT READY

COMM.OPT.



TRAY SEND

R

1x



PC SCANNER



START

PC READY ?



START

DOC.READING M98%

TRANSMITTING TO PC

15-03 19:56 M 100%

Insert document with text side down

Document is ready

Select communication option

Page through the menu...

...until you reach the desired menu item

Confirm with START

PC ready? *)

Confirm with START

Return to the standby mode

Sending fax messages from the PC

If you have for instance created text or graphics via a word processing program, you do not need to print out the text or graphics in order to send a fax document. Winfax PRO Software transfers your document via the cable from your PC to the fax machine together with the fax number which you have specified when you were processing the document. Following internal transmission, the job is then handled as a normal job in your fax machine.

RECEIVING FROM PC

JOB ACCEPTED NO.007

15-03 19:56 M 89%

PC is transmitting the fax data to the fax machine

PC transfer complete: the job is stored as a new job in the stack

Return to the standby mode

Depending on the contents of the stack, the job is soon sent by the fax machine.

Handling faxes on your PC

Sending faxes to the PC

If you have connected a PC to your fax machine, you can send documents directly to your PC.

The following requirements are essential for this process:

- Function number 46 (receive to PC) is set to ON (for setting, see [page 49](#)).
- The fax software (e.g. WinFax PRO) is loaded and activated.
- **The fax software is set to automatic reception.**
- The connection to the PC has been established.

The following error message is displayed if your fax machine cannot reach the PC:

PC COMM. ERROR #001

In this case, the incoming fax document is printed out on the fax machine. The error message does not affect the ability of the fax machine to receive further documents.



A fax document received in this way is stored in the form of an image file in the PC. An OCR program must process a file before any received text can be integrated in a word processing program. This is essential if this file is to be used as a text file (contained in WinFax PRO) .



It is essential to ensure that the fax software is set to automatic reception!

UK Connection information

This toshiba Facsimile Transceiver is intended for connection to public telecommunications services as follows:

By using the cable described as TEL LINE CABLE in the packaging list of the instruction manual. This cable plugs into the socket on the left hand side of the TF 461 which is marked LINE and the other end into the standard PSTN analogue socket found in the UK.

This terminal equipment complies with the following requirements:

- Group 3 Fax modem
- Automatic call initiation
- Storage of telephone numbers for retrieval by a predetermined code
- Automatic dialling
- Automatic repeat attempts
- Call progress monitor
- Series connection facility
- LD or MF dialling
- Operation with or without dial tone being present.

Any other usage will invalidate the approval of the apparatus if as a result, it then ceases to conform to the standards against which approval was granted.

We declare, that Toshiba is using  mark in compliance with EN 50 082-1, EN 55 022/B and EN 60 950

Index

ABB number	38	Job cancel	37	Receiving documents	16
ABB number list	45	Job handling	23	Receiving reduction	20
Access digit	12	Journal	44	Reception problems	58
				Redial	30
Bell times	21	Language	8	Reduction speed	36
Broadcasting	32	Line access	17	Remote Diagnostic	48
		Line problems	57	Resolution	30
Cable	60,87	Local copy	20	RTI	51
Cancel transmission	37				
Communication failure	55	Machine overview	1	Scanning	88
Connecting fax	4	Main station	12	Supstitute reception	21
Copy	20	Memory extension	24	Sending documents	25
		Memory reception	21	Software, fax-software	86
Date	15	Monitoring	29	Stack handling	23
Delayed transmission	31			Station name	10
Delete ABB numbers	39	One touch key	40	Storing ABB numbers	38
Dialling	25	Operation panel	1	Storing groups	40
Dialling method	11	Optional memory	24	Storing name	10
Direct transmission	24	Overseas communication	57	Storing numbers	38
Document jam	59	Overview	1		
				Temporary group	32
Earth key	12	Paper handling	5	Terminal identification	9
Error codes	55	Paper jam	59	Time	15
Error messages	56	Parameter list	46	Tone dial	11
Extension	12	PBAX	12	Toolkit	69
		PC fax	86	Transmission without memory	24
Fax transportation	6	Polling	39	Transportation	6
Faxmodem	86	Polling reservation	35	Troubleshooting	55
Flash	12	Pinter	6,60	TTI	9
Function list	46	Printer, spool manager	76	TX problems	57
		Printer status	75	TX report	43
Greyscale	30	Printer driver	63		
Groups	32	Printhead, change	61	UART	86
		Printhead, adjustment	83	Unpacking	4
Individual group	33	Printhead, cleaning	84		
Ink refill	6	Problems	55	Wall socket	4
Ink cartridge, change	61	Prohibit memory	24	Windows, default printer	81
Inserting receiving paper	5	PSTN	12	WinfaxPro	86
Installation	8	Puls dial	11		
Interface, parallel	60				
Interface, serial	86				